



# Hammond Enclosures

Plastic, Diecast,  
Aluminium Boxes



## Contents

Part Number	Description	Pg.	Colour	Material	Handheld	Batt Door	Flanged Lid	Flanged Base	UV Resistant	IP54	IP65	IP66
General Purpose - Misc.		1										
<b>Plastic</b>												
26-1551	Miniature - Handheld	2	BK/GY/TB	ABS	Y					Y		
26-1551FL	Miniature - Flanged Lid	3	BK/GY	ABS			Y			Y		
26-1553	Handheld Soft Sided	4	BK/GY/TB/R/Y	ABS	Y	Y						
26-1554/55	Watertight - Flat and Recessed Lids	5	GY	ABS								Y
26-1554/55	Watertight - Polycarbonate - 4 Lid Options	6	GY/CL/SM	PC								Y
26-1590ZGRP	Watertight - Glassfilled Polyester	7	GY	GRP					Y		Y	
26-1591XX/FL	Multipurpose Flame Retardant	8	BY/GY	FRABS			Y			Y		
26-1591XX/TBU	Multipurpose Translucent Blue	9	TB	ABS						Y		
26-1591XXS/SFL	Multipurpose Economical Box	10	BK	ABS			Y			Y		
26-1591T	Translucent Polycarbonate Box	11	IB/IRD/CL	PC						Y		
26-1591	Multipurpose Flame Retardant	12	BK/BG/BL/GY	FRABS						Y		
26-1592	Hand Held Display Box	13	BK/GY	FRABS	Y							
26-1591S	Multipurpose Boxes S Series	14	BK/GY	GP						Y		
26-1591FL	Multipurpose Boxes FL Series	14	BK/GY	FRABS			Y			Y		
26-1591FLS	Multipurpose Boxes FLS Series	14	BK	GP			Y			Y		
26-1591 F2/F2S	Multipurpose Flanged Boxes	15	BK/GY	GP/ABS				Y		Y		
26-1593	Hand Held Instrument Boxes	16	BK/GY	ABS	Y	Y						
26-1553T	Soft Side Hand Held Enclosure	17	BK/GY	FRABS	Y	Y				Y		
26-1593	Hand Held Instrument Boxes	18	BK/GY/TB	ABS	Y	Y						
26-1593HAM	Enclosures for Development Boards	19	BK/GY/TB	ABS								
26-1594RFI	Thick Wall RFI - Conductive Plastic	20	BK	FRABS						Y		
26-1599RFI	RFI - Hand Held Conductive Plastic	20	BK	FRABS	Y					Y		
1594/S/W	Economy/FRABS Heavy Duty Boxes	21	GY	GP/FRABS						Y		
26-1595	Sloping ABS Console Boxes	22	BK/GY	FRABS								
26-1596	Potting Boxes	23	BK	ABS								
26-1597	Takachi Boxes	24	BK/GY	ABS								
26-1598/S/SP	Desktop Instrument Boxes	25	BK/GY	GP/FRABS						Y		
26-1599TAB	Hand Held Tablet Enclosures	26	BK/GY	FRABS	Y	Y				Y		
26-1599/S	Hand Held Boxes	27	BK/GY	GP/FRABS	Y	Y				Y		
26-1599T/TS	Short Slope Desktop Instrument Boxes	28	BK/GY	GP/FRABS						Y		
26-1599TL/STL	Long Slope Desktop Instrument and PJ Series Neema Boxes	29	BK/GY	GP/FRABS		Y				Y		
26-RH	RITEC Hand Held Boxes - RH Series	30	GY	ABS	Y	Y				Y		
26-RL	Hand Held/Flanged Lid Shallow/Deep Lid	31	GY	ABS			Y			Y		
26-RM	Plastic Instrument Box - Two Part	32	GY	ABS								
26-RP	RITEC Watertight - Clear Lid Option	33	GY/GY & CL	ABS/PC								Y

## Contents continued

Part Number	Description	Pg.	Colour	Material	Handheld	Batt Door	Flanged Lid	Flanged Base	UV Resistant	IP54	IP65	IP66
26-RP	RITEC Watertight - Deep Lid	34	GY/GY & CL	ABS/PC							Y	
26-RS	RITEC Sealed Plastic - Lid Gasket Option	34	GY	ABS							Y	
<b>Extruded Aluminium</b>												
26-1455 "01"	Extruded Aluminium - Metal End Panels	35	BK/NAT	AL								
26-1455 "02"	Extruded Aluminium - Plastic End Panels	36	BK/NAT	AL								
26-1455NC	Extruded Aluminium - Channel Mount	37	NAT	AL								
26-1455NC	Channel Mounting Kits	37	NAT	AL								
26-1455ZT	Extruded Aluminium - Wall Mounting	38	BK/NAT	AL			Y					
26-R250	ROLEC Aluminium - To House P.C Boards	39	SIL	AL						Y	Y	
26-1455	Accessory Flange Kits	40	BK/NAT	AL								
	Replacement Parts & Bezel Options	40	BK/R/Y/TB/IRD	AL								
26-1457	Extruded Aluminium - Watertight	41	BK/NAT	AL							Y	
26-1457 E	Extruded Aluminium - EMI/RFI Gaskets	41	BK/NAT	AL						Y		
<b>Diecast Aluminium</b>												
26-1590	Diecast Aluminium	42	BK/UNP	AL						Y		
26-1590 F	Diecast Aluminium - Flanged Base	43	BK/UNP	AL				Y		Y		
26-1590 FL	Diecast Aluminium - Flanged Lid	44	BK/UNP	AL			Y			Y		
26-1590	Diecast Aluminium - PCB Card Guides	45	BK/UNP	AL			Y	Y		Y		
26-1590	Painted Stomp Box	46	Colours	AL						Y		
26-1590	Painted Octagon/Trapezoid Enclosures	47	BK/UNP	AL						Y		
26-1590K	Zinc Diecast	48	UNP	ZINC						Y		
Eddystone	Eddystone Diecast Aluminium - Thin Wall	49	UNP	AL						Y		
26-1550/W	Diecast Aluminium - Light Duty Watertight	50	BK/UNP	AL						Y		Y
<b>Watertight Diecast Aluminium</b>												
26-1550W	Watertight Diecast Aluminium	51	BK/UNP	AL								Y
26-1590W F	Diecast Aluminium - Flanged Base	52	BK/UNP	AL				Y			Y	
26-1590W FL	Diecast Aluminium - Flanged Lid	53	BK/UNP	AL			Y				Y	
26-1590W	Diecast Aluminium - PCB Card Guides	54	BK/UNP	AL			Y	Y			Y	
26-1590Z	Watertight - Heavy Duty	55	BK/UNP/GY	AL							Y	

Contents continued

Description	Pg.	Colour	Material	Handheld	Batt Door	Flanged Lid	Flanged Base	UV Resistant	IP54	IP65	IP66
Hammond Transformers	56	-									
Other Hammond Enclosure	57	-									
Accessories - Handles, Rubber Feet and Tilt Stands	58	-									
Accessories - Miscellaneous	59	-									
Properties of Materials and I.P. Protection Codes	60	-									
Other Products of Hi-Q Components	61	-									

BK = Black  
BL = Blue  
BG = Beige  
CL = Clear  
GY = Grey  
IB = Ice Blue  
IRD = IR Transparent Red

RD = Red  
SIL = Silver  
SM = Smoked  
TB = Transparent Blue  
UNP = Unpainted  
Y = Yellow  
ABS = ABS

AL = Aluminium  
FRABS = Fire resistant ABS  
UL 94Ø  
FRPC = Flame Retardant  
Polycarbonate  
GRP = Glass Filled Polyester  
GP = General purpose

economy plastic  
NAT = Natural anodized  
PC = Polycarbonate  
POLY = Polyester  
ZINC = Zinc

## Hi-Q Misc. General Purpose - PB Series

Low cost • Material: Black Styrene

Part Number	Length	Width	Height
26-PB004	50	35	21
26-PB005	50	35	27
26-PB013	84	54	30
26-PB122	122	72	48



PB004  
PB005

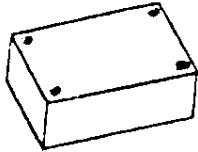

PB013

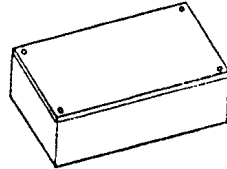

PB122

## ABS Utility Box

High impact black ABS plastic UL94VØ • PCB access for Switch /Connector /Display • Mounting Flanges

Part Number	Length	Width	Height
26-UB9278	92	56	30

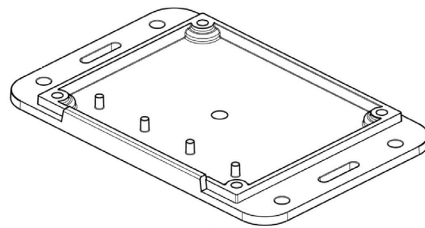
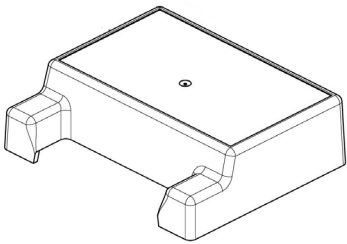

## Hammond Miniature Hand Held Boxes - 1551/1551TBU

Designed to meet IP54 • Two PCB spacers are moulded into the interior.

- Ideally suited for mounting small printed circuit boards.
- Moulded from economical ABS plastic and feature a satin finish.
- Assembled with two self tapping screws.
- Lap joint construction provides protection from dust and splashing water.
- Part number with "\*" are available with a key ring kit.

For detailed drawings and CAD files visit [www.hammondmfg.com](http://www.hammondmfg.com)

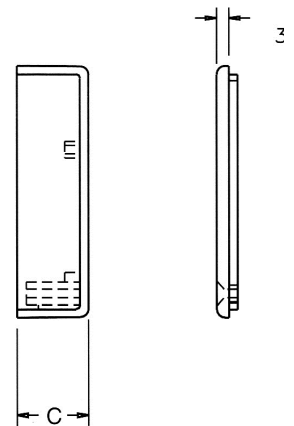
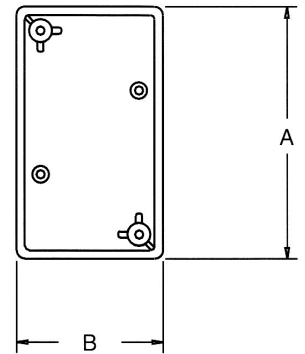
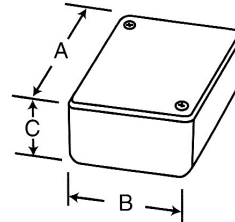

### Accessories

#### Key Ring Kit (19mm ring plus black nylon clip)

Part No. 26-1427KR

Mounting Hole Size 4.0mm

#### Internal PCB Screws (#2 x 3/16" Self Tapper)

Part No. 26-1551ATS100

Part Number			Dimensions with Lid (mm)		
Black	Grey	Translucent Blue	A (L)	B (W)	C (H)
26-1551NBK	26-1551NGY	26-1551NTBU	35	35	15
26-1551MBK	26-1551MGY	26-1551MTBU	35	35	20
26-1551QBK	26-1551QGY	26-1551QTBU	40	40	15
26-1551PBK	26-1551PGY	26-1551PTBU	40	40	20
26-1551FBK	26-1551FGY	26-1551FTBU	50	35	15
*26-1551GBK	*26-1551GGY	26-1551GTBU	50	35	20
26-1551SBK	26-1551SGY	26-1551STBU	50	50	15
26-1551RBK	26-1551RGY	26-1551RTBU	50	50	20
26-1551JBK	26-1551JGY	26-1551JTBU	60	35	15
*26-1551HBK	*26-1551HGY	26-1551HTBU	60	35	20
26-1551LBK	26-1551LGY	26-1551LTBU	80	40	15
*26-1551KBK	*26-1551KGY	26-1551KTBU	80	40	20

## Hammond Miniature Flanged Lid Boxes - 1551FL

Designed to meet IP54 • Two PCB spacers are moulded into the interior.

- Ideally suited for mounting small printed circuit boards.
- Moulded from economical ABS plastic and feature a satin finish.
- Flanged lid is perfect for wall or shelf mounting or suspending with a tie wrap.
- Assembled with two self tapping screws.
- Lap joint construction provides protection from dust and splashing water

For detailed drawings and CAD files visit [www.hammondmfg.com](http://www.hammondmfg.com)



### Accessories

**Internal PCB Screws** (#2 x 3/16" Self Tapper)  
Part No. 26-1551ATS100  
- Not included with enclosure

Part Number		Dimensions (mm)		
Black	Grey	Length	Width	Height (with lid)
26-1551NFLBK	26-1551NFLGY	35	35	15
26-1551MFLBK	26-1551MFLGY	35	35	20
26-1551QFLBK	26-1551QFLGY	40	40	15
26-1551PFLBK	26-1551PFLGY	40	40	20
26-1551FFLBK	26-1551FFLGY	50	35	15
26-1551GFLBK	26-1551GFLGY	50	35	20
26-1551SFLBK	26-1551SFLGY	50	50	15
26-1551RFLBK	26-1551RFLGY	50	50	20
26-1551JFLBK	26-1551JFLGY	60	35	15
26-1551HFLBK	26-1551HFLGY	60	35	20
26-1551LFLBK	26-1551LFLGY	80	40	15
26-1551KFLBK	26-1551KFLGY	80	40	20

## Hammond Soft Sided Hand Held Boxes - 1553

IR Panel option • Prototype PCBs available • P.C. board standoffs are molded into case

- Designed for hand held comfort.
- Moulded from economical ABS plastic with a black overmold, soft plastic grid.
- Removable front panel (for easy modifications) and assembly of hardware.
- Battery door & compartment version includes 4 battery clips (for 2-AA batteries) and a 9 volt (PP3) battery clip.

For detailed drawings and CAD files visit [www.hammondmfg.com](http://www.hammondmfg.com)

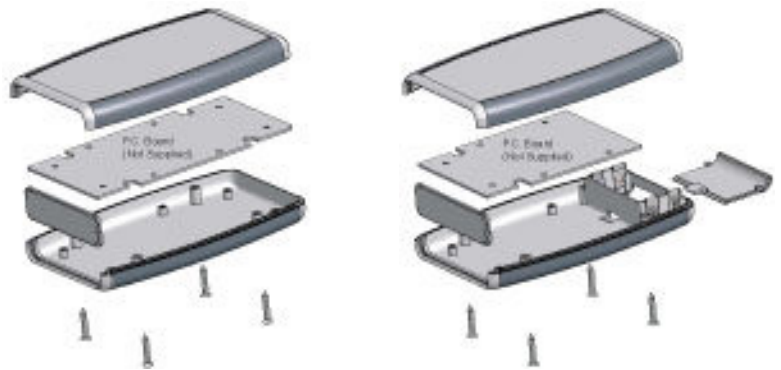

### SECTION B-B (Inside of Bottom Cover)

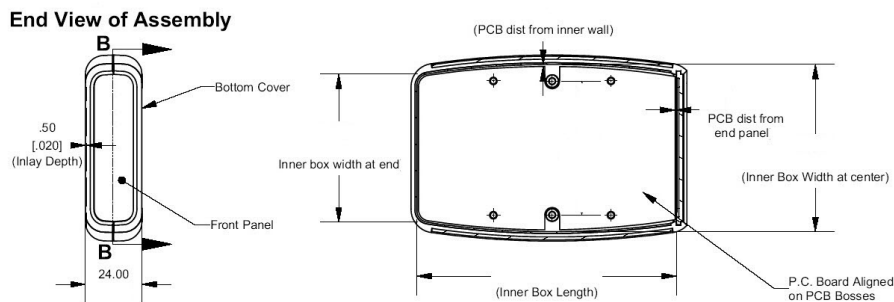

Part Number				Dimensions (mm)		
Black and Grey	Translucent Blue	Red	Yellow	Length	Width	Height
26-1553BBK & 26-1553BGY	26-1553BTBUBK	26-1553BRDBK	26-1553BYLBK	117	79	24
26-1553DBK & 26-1553DGY	26-1553DTBUBK	26-1553DRDBK	26-1553DYLBK	147	89	24
26-1553BBKBAT & 26-1553BGYBAT	26-1553BTBUBKBAT	26-1553BRDBKBAT	26-1553BYLBKBAT	117	79	24
26-1553DBKBAT & 26-1553DGYBAT	26-1553DTBUBKBAT	26-1553DRDBKBAT	26-1553DYLBKBAT	147	89	24



## Hammond Watertight ABS Flat Lid Boxes - 1554 / 1555

Rugged electronic or electrical watertight enclosure • Mounting feet available

- Light grey ABS material carries a rating of UL94 HB and is not recommended for outdoor use.
- Refer to Polycarbonate series for outdoor use.
- Lid is secured with self capturing M4 stainless machine screws into integral stainless steel bushings to avoid corrosion with dissimilar metals.
- Gasketed lid with high temp. UL listed silicon gasket material and 2 piece 'tongue & groove' construction to protect against access of oil, dust and water.
- Meets IP 66 & NEMA 4, 4X, 12 & 13 ratings.
- Vertical card guides moulded in and integral PCB mounts and DIN rail mounting tabs except for smallest sizes BGY & CGY of both series. Options vary with the size. Refer to photo tables on www.hammondmfg.com. For internal views of each size, also for detailed drawings and CAD files.

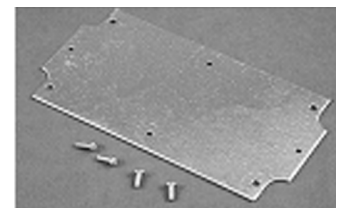
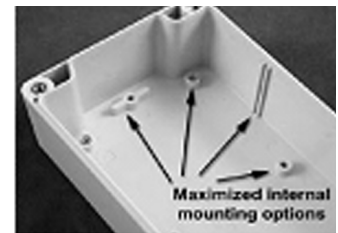

Optional gear plate



26-1554 Series Flat lid

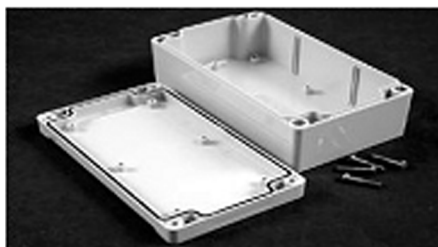

26-1555 Series Recessed lid for membrane keypad & PCB spacers moulded into lid.



### Accessories

Feet Kit  
(Part Number 26-1554FT)  
Feet allow box to mount horizontally or vertically.

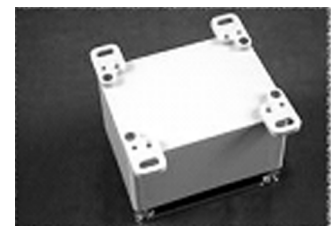

Part Number - ABS		Dimensions (mm)		
Flat Lid	Recessed Lid	Length	Width	Height (Base Only)
26-1554BGY	26-1555BGY	65	65	40
26-1554EGY	26-1555EGY	90	90	60
26-1554CGY	26-1555CGY	120	65	40
26-1554DGY	26-1555DGY	120	65	60
26-1554FGY	26-1555FGY	120	90	60
26-1554GGY	26-1555GGY	120	90	80
26-1554NGY	26-1555NGY	120	120	60
26-1554PGY	26-1555PGY	120	120	80
26-1554JGY	26-1555JGY	160	90	60
26-1554KGY	26-1555KGY	160	90	90
26-1554RGY	26-1555RGY	160	160	60
26-1554SGY	26-1555SGY	160	160	90
26-1554HGY	26-1555HGY	180	120	60
26-1554TGY	26-1555TGY	180	120	90
26-1554UGY	26-1555UGY	200	120	90
26-1554VGY	26-1555VGY	240	160	90

**Hammond Watertight Polycarbonate - 1554/5 Series 2 Lids - Flat, Recessed, Clear & Smoked**  
Rugged electronic or electrical watertight & weather resistant enclosure

- Light grey (RAL 7035) polycarbonate material carries a rating of UL94 5V and is recommended for outdoor use. Smoked Lid, Clear flat polycarbonate lid "2CL" series for use with sensors and photovoltaics.
- Lid is secured with self captivating M4 stainless machine screws into integral stainless steel bushings to avoid corrosion with dissimilar metals.
- Gasketed lid with high temperature UL listed silicon gasket material and 2 piece tongue & groove' construction to protect against access of oil, dust and water.
- Meets IP 66 & NEMA 4, 4X, 12 & 13 ratings
- Vertical card guides, integral PCB mounts and DIN rail mounting tabs moulded in except for the smallest sizes B2GY & C2GY / B2GYCL & C2GYCL of both series.
- Options vary with size. Refer to photo tables on [www.hammondmfg.com](http://www.hammondmfg.com) for internal views of each size, also for detailed drawings and CAD files.
- Gear Plates and mounting feet available.



**26-1554 '2' Series** Flat lid, clear and smoked lid options



**16-1554 '2CL' Series**



**26-1555 '2' Series** Recessed lid for membrane keypad & PCB spacers in lid



**26-1554 '2SL' Series**

Part Number - Polycarbonate				Dimensions (mm)		
Flat Lid	Flat Clear Lid	Flat Smoked Lid	Recessed Lid	Length	Width	Height (with lid)
26-1554B2GY	26-1554B2GYCL	26-1554B2GYSL	26-1555B2GY	65	65	40
26-1554E2GY	26-1554E2GYCL	26-1554E2GYSL	26-1555E2GY	90	90	60
26-1554C2GY	26-1554C2GYCL	26-1554C2GYSL	26-1555C2GY	120	65	40
26-1554D2GY	26-1554D2GYCL	26-1554D2GYSL	26-1555D2GY	120	65	60
26-1554F2GY	26-1554F2GYCL	26-1554F2GYSL	26-1555F2GY	120	90	60
26-1554G2GY	26-1554G2GYCL	26-1554G2GYSL	26-1555G2GY	120	90	80
26-1554N2GY	26-1554N2GYCL	26-1554N2GYSL	26-1555N2GY	120	120	60
26-1554P2GY	26-1554P2GYCL	26-1554P2GYSL	26-1555P2GY	120	120	80
26-1554J2GY	26-1554J2GYCL	26-1554J2GYSL	26-1555J2GY	160	90	60
26-1554K2GY	26-1554K2GYCL	26-1554K2GYSL	26-1555K2GY	160	90	90
26-1554R2GY	26-1554R2GYCL	26-1554R2GYSL	26-1555R2GY	160	160	60
26-1554S2GY	26-1554S2GYCL	26-1554S2GYSL	26-1555S2GY	160	160	90
26-1554H2GY	26-1554H2GYCL	26-1554H2GYSL	26-1555H2GY	180	120	60
26-1554T2GY	26-1554T2GYCL	26-1554T2GYSL	26-1555T2GY	180	120	90
26-1554U2GY	26-1554U2GYCL	26-1554U2GYSL	26-1555U2GY	200	120	90
26-1554V2GY	26-1554V2GYCL	26-1554V2GYSL	26-1555V2GY	240	160	90

## Hammond Watertight Glassfilled Polyester Boxes - 1590ZGRP

Rugged heavy duty thick wall watertight enclosure. • Designed to meet IP65.

- Internal threaded mounting inserts moulded into box.
- Easy wall mounting via 'through box' holes without affecting gasket protection.
- Individually shrink wrapped for protection.
- Material: Grey, glass reinforced polyester, smooth front.
- Gasket material is Mohogumi rubber (EDPM).

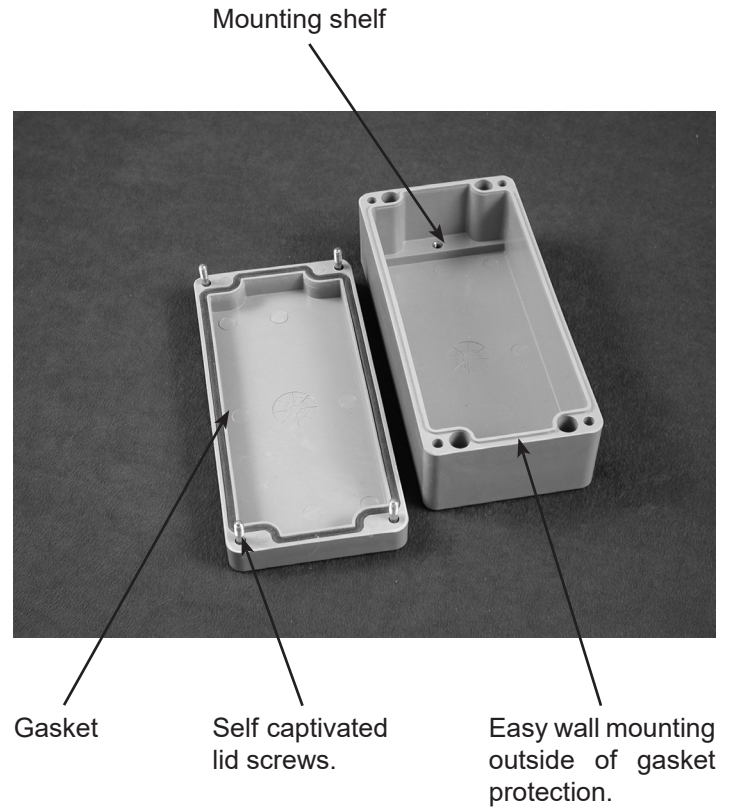

Part Number	Length	Width	Height (Base)	Height of Lid
26-1590ZGRP081	80	75	40	15
26-1590ZGRP082	110	75	40	15
26-1590ZGRP121	120	122	65	25
26-1590ZGRP083	160	75	40	15
26-1590ZGRP161	160	160	70	20
26-1590ZGRP131	190	75	40	15
26-1590ZGRP233	200	250	95	20
26-1590ZGRP123	220	120	65	25
26-1590ZGRP234	255	250.8	95	25.25
26-1590ZGRP235	255	250.8	95	65.5
26-1590ZGRP162	260	160	70	20
26-1590ZGRP243	400	250	95	25.25
26-1590ZGRP263	600	250	95	25

## Hammond Multipurpose Flame Retardant ABS Boxes - 1591XX - 1591XX "FL" Series

Ideally suited for mounting printed circuit boards horizontally • Smooth Internal walls • Flanged lid type available

- Splash and dust proof to meet IP54
- PC Board standoffs moulded into lid and box
- Easy to machine material, UL rating 94V-0.
- Lid is secured with M3 x 10mm, Philips machine screw, threaded into integral brass bushing

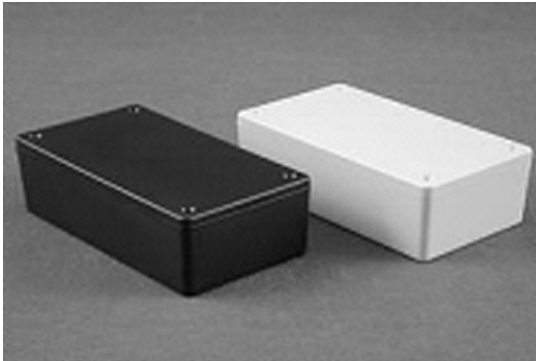

**26-1591XX** Flame Retardant ABS

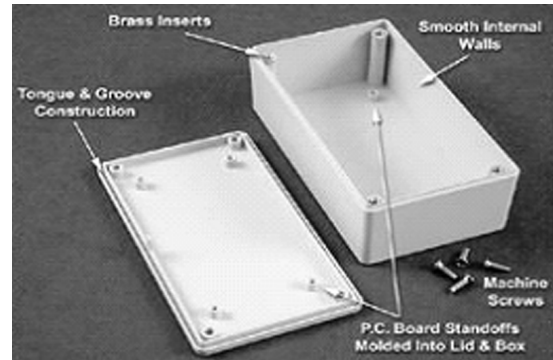

**26-1591XXFL** Flame Retardant ABS Flanged Lid

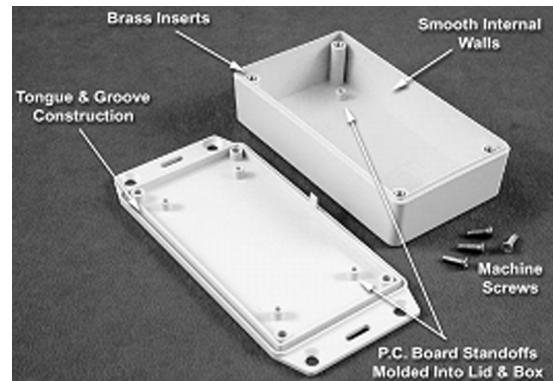

Part Number				Length	Width	Height (Less Lid)
1591XX Series		1591XX FL Series				
Black	Grey	Black	Grey			
26-1591XXMBK	26-1591XXMGY	26-1591XXMFLBK	26-1591XXMFLGY	85	56	21
26-1591XXLBK	26-1591XXLGY	26-1591XXLFLBK	26-1591XXLFLGY	87	57	36
26-1591XXABK	26-1591XXAGY	26-1591XXAFLBK	26-1591XXAFLGY	100	51	22
26-1591XXSBK	26-1591XXSGY	26-1591XXSFLBK	26-1591XXSFLGY	110	82	40
26-1591XXBBK	26-1591XXBGY	26-1591XXBFLBK	26-1591XXBFLGY	113	63	28
26-1591XXCBK	26-1591XXCGY	26-1591XXCFLBK	26-1591XXCFLGY	121	66	37
26-1591XXTBK	26-1591XXTGY	26-1591XXTFLBK	26-1591XXTFLGY	123	83	56
26-1591XXGBK	26-1591XXGGY	26-1591XXGFLBK	26-1591XXGFLGY	121	94	30
26-1591XXDBK	26-1591XXDGY	26-1591XXDFLBK	26-1591XXDFLGY	152	82	47
26-1591XXEBK	26-1591XXEGY	26-1591XXEFLBK	26-1591XXEFLGY	193	113	58
26-1591XXFBK	26-1591XXFGY	26-1591XXFFLBK	26-1591XXFFLGY	221	150	60

## Hammond Multipurpose Translucent Blue ABS Boxes - 1591XX TBU

Ideally suited for mounting printed circuit boards horizontally • Smooth Internal Walls

- Splash and dust proof box to meet IP54.
- PC Board standoffs moulded into lid and box .
- Lid is secured with M3 x 10mm Philips machine screw, threaded into integral brass bushing.
- Tongue and groove lid to Box construction.
- Moulded from easy to machine, translucent blue ABS plastic, with a satin texture.

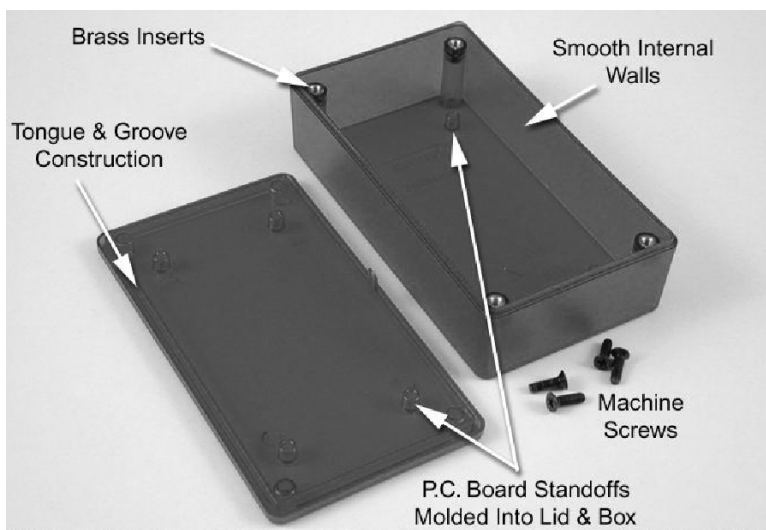

Top

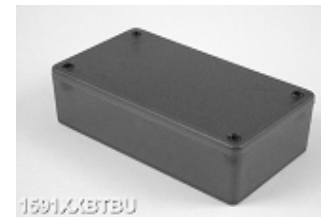

Bottom

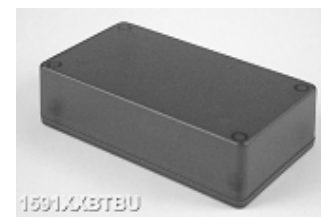

Part Number	Length	Width	Height (Less Lid)
<b>ABS</b>			
<b>Transparent Blue</b>			
26-1591XXMTBU	85	56	21
26-1591XXLTBU	87	57	36
26-1591XXATBU	100	51	22
26-1591XXSTBU	110	82	40
26-1591XXBTUB	113	63	28
26-1591XXCTBU	121	66	37
26-1591XXTTBU	123	83	56
26-1591XXGTBU	121	94	30
26-1591XXDTBU	152	82	47
26-1591XXETBU	193	113	58

**Hammond Multipurpose Economical ABS Boxes - 1591XX "S" Series - 1591XX "S" FL Series**  
Ideally suited for mounting printed circuit boards horizontally • Smooth Internal walls

- Splash and dust proof box to meet IP54.
- PC Board standoffs moulded into lid and box.
- Flanged lid is perfect for wall or shelf mounting and enclosure security.
- Lid is secured with Black #4 x 0.5" Philips screws.
- Material— economical black plastic.



1591XX "S"



1591XX "S" FL

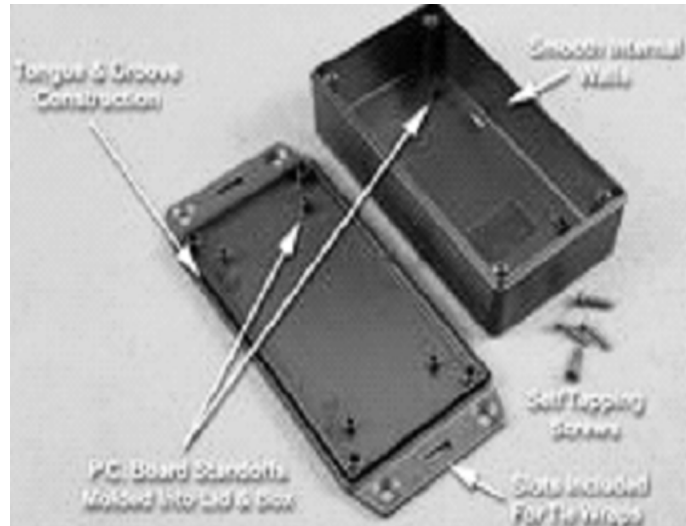

1591XX "S" FL ( Flanged Lid)

Part Number		Length	Width	Height (Less Lid)
1591XX "S" Black	1591XX "S" FL Black			
26-1591XXMSBK	26-1591XXMSFLBK	85	56	21
26-1591XXLSBK	26-1591XXLSFLBK	87	57	36
26-1591XXASBK	26-1591XXASFLBK	100	51	22
26-1591XXSSBK	26-1591XXSSFLBK	110	82	40
26-1591XXBSBK	26-1591XXBSFLBK	113	63	28
26-1591XXCSBK	26-1591XXCSFLBK	121	66	37
26-1591XXTSBK	26-1591XXTSFLBK	123	83	56
26-1591XXGSBK	26-1591XXGSFLBK	121	94	30
26-1591XXDSBK	26-1591XXDSFLBK	152	82	47
26-1591XXESBK	26-1591XXESFLBK	193	113	58
26-1591XXFSBK	26-1591XXFSFLBK	221	150	60

**Accessories:**

Accessory screws for mounting P.C. boards into standoffs (#4 x 1/4" pan head)  
Part Number 26-1593ATS100 (qty. 100).

## Hammond Translucent Polycarbonate Boxes 1591T

Splash and dust proof box designed to meet IP54. • Individually shrink wrapped for protection.

- Ideally suited for modern styles where internal components need to be visible.
- Integral Guides for PC cards.
- Material: Flame retardant polycarbonate (UL flammability rating of 94-V0).

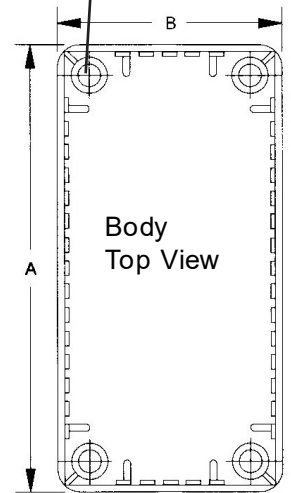
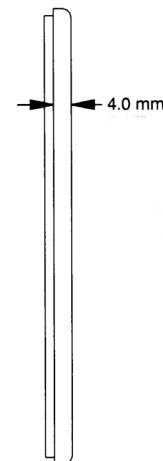
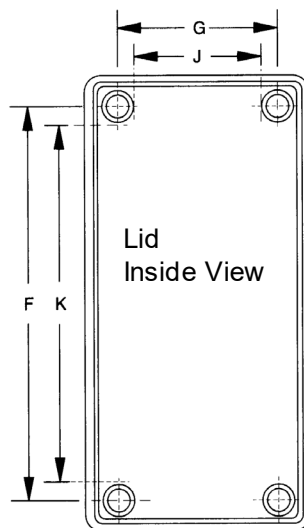
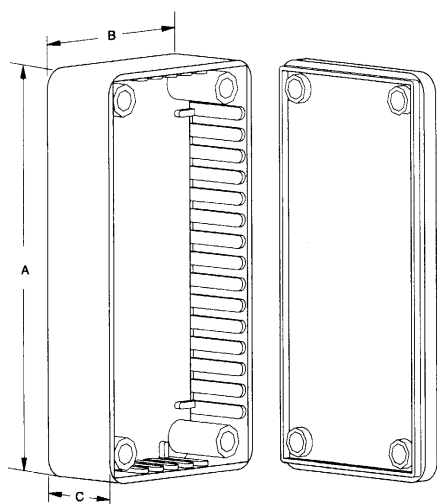
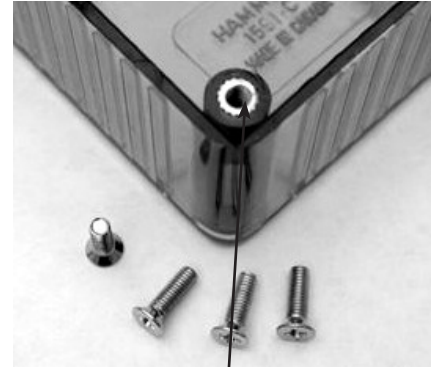

Assembled height = Body height dimension 'C' + Lid thickness (4.0mm)

For detailed drawings & CAD files visit website [www.hammondmfg.com](http://www.hammondmfg.com)

Part Number			Dimensions (mm)						
Ice Blue	IR Red	Clear	A	B	C	F	G	J	K
26-1591ATBU	26-1591ATRD	26-1591ATCL	100	50	21	86	36	29	79
26-1591BTBU	26-1591BTRD	26-1591BTCL	112	62	27	98	48	41	91
26-1591CTBU	26-1591CTRD	26-1591CTCL	120	65	36	106	51	44	99
26-1591DTBU	26-1591DTRD	26-1591DTCL	150	80	46	136	66	59	129
26-1591ETBU	26-1591ETRD	26-1591ETCL	191	110	57	176	96	89	80.1
26-1591STBU	26-1591STRD	26-1591STCL	110	82	40	96.2	68.4	60.4	88.3

Unit assembled with M3 x 10 Phillips machine screws into tapped brass inserts for repetitive assembly and disassembly.

## Hammond Multipurpose Flame Retardant ABS - 1591

Splash and dust proof box to meet IP54. • Integral Vertical guides for PC cards

- Individually shrink wrapped for protection
- Material: Flame retardant ABS plastic. UL94VØ
- Lid is secured with M3x 10 Phillips machine screws

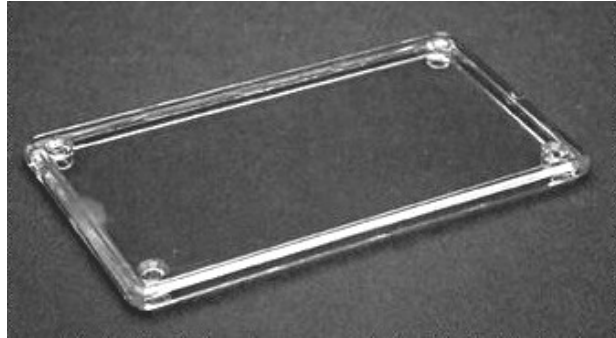

Clear FR  
Polycarbonate  
lids available

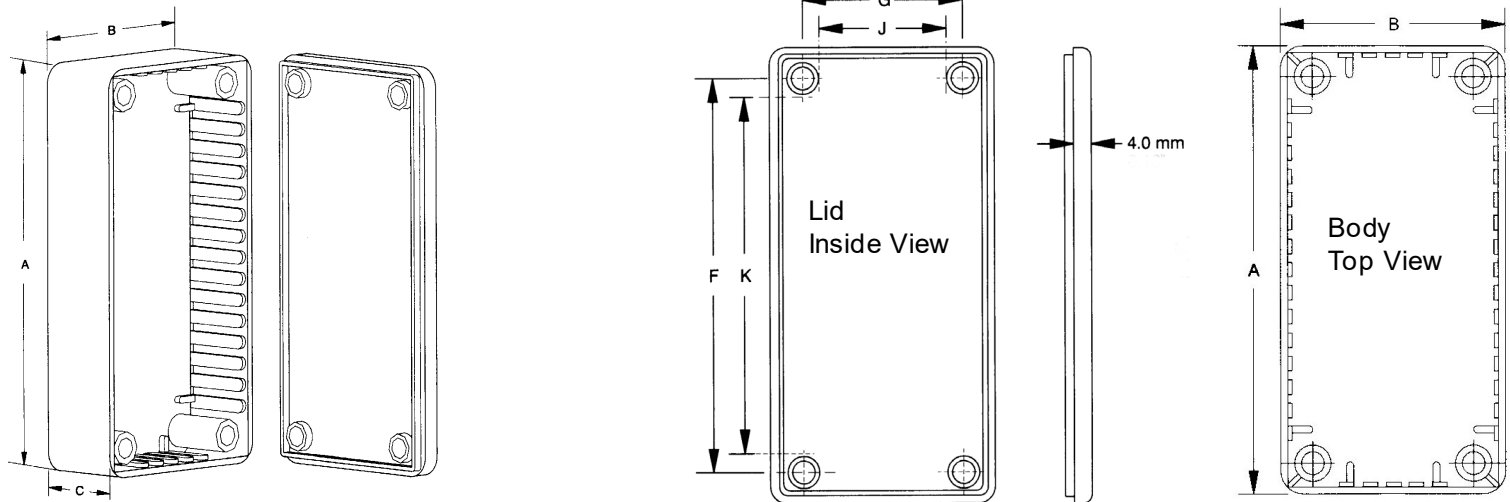

Part Number				Dimensions (mm)						
Black	Beige	Blue	Grey	A	B	C	F	G	J	K
26-1591MBK	26-1591MBG	26-1591MBU	26-1591MGY	85	56	21	71	42	34	63
26-1591LBK	26-1591LBG	26-1591LBU	26-1591LGY	85	56	35	73	44	35	64
26-1591ABK	26-1591ABG	26-1591ABU	26-1591AGY	100	50	21	86	36	29	79
26-1591SBK	26-1591SBG	26-1591SBU	26-1591SGY	110	82	40	98	70	61	89
26-1591BBK	26-1591BBG	26-1591BBU	26-1591BGY	112	62	27	98	48	41	91
26-1591CBK	26-1591CBG	26-1591CBU	26-1591CGY	120	65	36	106	51	44	99
26-1591TBK	26-1591TBG	26-1591TBU	26-1591TGY	120	80	55	106	66	59	99
26-1591UBK	26-1591UBG	26-1591UBU	26-1591UGY	120	120	55	106	106	99	99
26-1591VBK	26-1591VBG	26-1591VBU	26-1591VGY	120	120	90	106	106	99	99
26-1591GBK	26-1591GBG	26-1591GBU	26-1591GGY	121	94	30	106	79	73	100
26-1591DBK	26-1591DBG	26-1591DBU	26-1591DGY	150	80	46	136	66	59	129
26-1591HBK	26-1591HBG	26-1591HBU	26-1591HGY	165	71	25	153	56	50	144
26-1591EBK	26-1591EBG	26-1591EBU	26-1591EGY	191	110	57	176	96	89	170

### ABS Boxes

Unit assembled with M3 x 10 Phillips machine screws into tapped brass inserts.

1591E & 1591H have centre pillars. For detailed drawings & CAD files visit website [www.hammondmfg.com](http://www.hammondmfg.com)

Assembled height = Body height 'C' + Lid thickness (4.0mm) \*

Also available in: ABS Beige (BG), Blue (BU) and Grey (GY)



## Hammond Hand Held Display Box – 1592

Designed as mobile data enclosure requiring a keypad and display • Material: FR ABS in Black or Grey.

- Available with either a solid display area or clear lens opening.
- Rubber feet fit into the recessed screw areas to provide a standoff and additional sealing from dirt and moisture.
- With proper sealing of the display lens, other modifications and the use of the gasket, the unit will provide protection from dirt, dust and liquids.
- Ergonomically designed for a comfortable fit in the users hand.
- Shrink wrapped for protection.

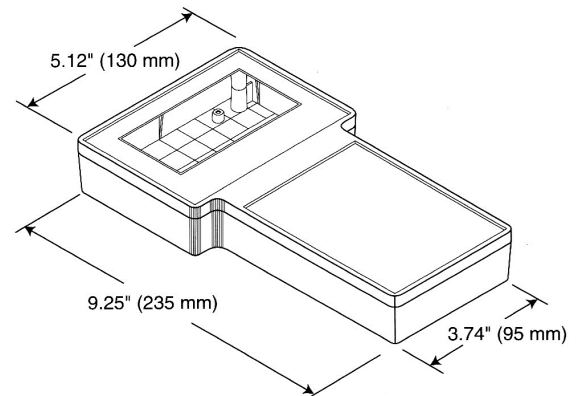
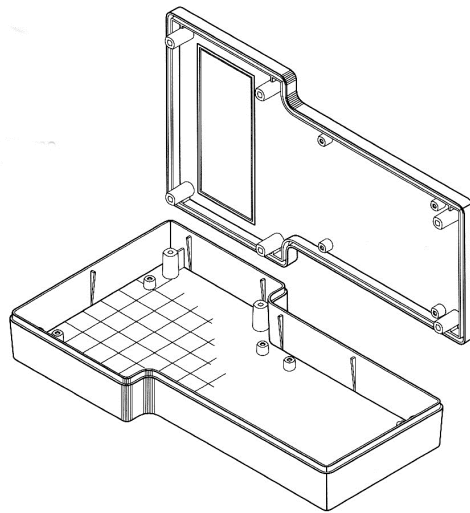
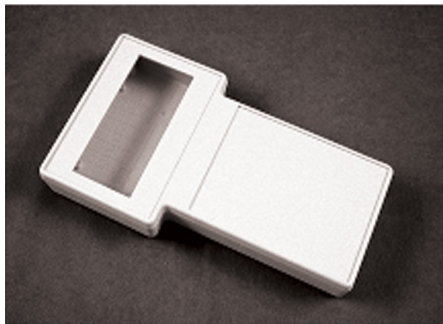
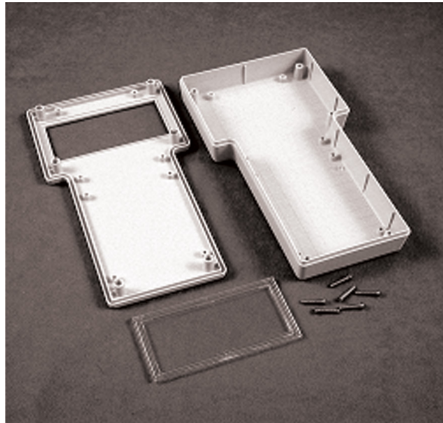

For detailed drawings and CAD files visit [www.hammondmfg.com](http://www.hammondmfg.com)

Part Number	Colour	Description	Length	Width	Depth
26-1592ETSDGY	Grey	Grey case with solid display area	234mm	130mm	34mm
26-1592ETSDBK	Black	Black case with solid display area	234mm	130 mm	34mm
26-1592RETSDBK	Black	Black shielded case with solid display area			
26-1592ETCDGY	Grey	Grey case, open display insert, clear polycarbonate lens kit	234mm	130mm	34mm
26-1592ETCDBK	Black	Black case, open display insert, clear polycarbonate lens kit	234mm	130mm	34mm

### Options Available

26-1592ETG	Gasket kit with 0.76 metre of gasket (for 1 unit)
26-1592RF	Rubber feet (kit of 6)
26-1592ETM	Magnetic strip 7.62 cm square
26-1592ETV	Velcro mounting tab
26-1592MS100	M3x20mm countersunk flat head replacement screws (100)

## Hammond Multipurpose Boxes

### Hammond Multipurpose Boxes - 1591 S Series

- Splash and dust proof to meet IP54.
- Material: General purpose black or grey plastic.
- Integral guides for PC cards.
- Individually shrink wrapped for protection.
- Assembled with self tapping screws.



### Hammond Multipurpose Flanged Lid Boxes - 1591 FL/FLS Series

- Splash and dust proof to meet IP54.
- FL Material: Flame retardant ABS plastic - UL94VØ
- FLS Material: Economy Plastic
- Designed for wall or shelf mounting.
- Integral guides to accept 1.5mm PC cards.
- Individually shrink wrapped for protection.
- FL assembled with M3 x 10 Phillips machine screws into tapped brass inserts
- FLS assembled with self tapping screws.

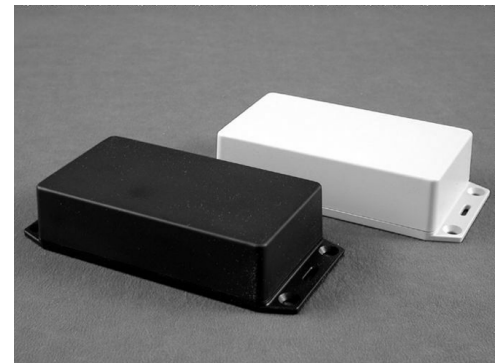
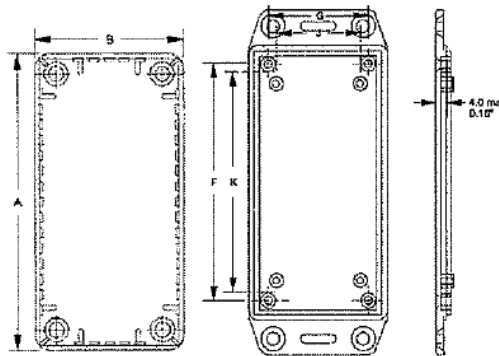
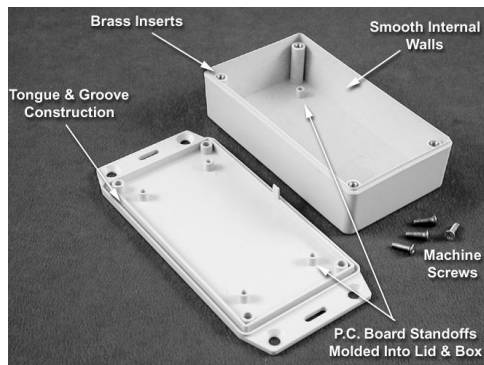

#### Part Numbers:

Economy Plastic "S" Series		FR ABS "FL" Series		Economy Plastic "FLS" Series	Dimensions (mm)		
Black	Grey	Black	Grey	Black	A	B	C
26-1591MSBK	26-1591MSGY	26-1591MFLBK	26-1591MFLGY	26-1591MSFLBK	85	56	21
26-1591LSBK	26-1591LSGY	26-1591LFLBK	26-1591LFLGY	26-1591LSFLBK	85	56	35
26-1591ASBK	26-1591ASGY	26-1591AFLBK	26-1591AFLGY	26-1591ASFLBK	100	50	21
26-1591SSBK	26-1591SSGY	26-1591SFLBK	26-1591SFLGY	26-1591SSFLBK	110	82	40
26-1591BSBK	26-1591BSGY	26-1591BFLBK	26-1591BFLGY	26-1591BSFLBK	112	62	27
26-1591CSBK	26-1591CSGY	26-1591CFLBK	26-1591CFLGY	26-1591CSFLBK	120	65	36
26-1591TSBK	26-1591TSGY	26-1591TFLBK	26-1591TFLGY	26-1591TSFLBK	120	80	55
26-1591USBK	26-1591USGY	26-1591UFLBK	26-1591UFLGY	26-1591USFLBK	120	12	55
26-1591VSBK	26-1591VSGY	26-1591VFLBK	26-1591VFLGY	26-1591VSFLBK	120	12	90
26-1591GSBK	26-1591GSGY	26-1591GFLBK	26-1591GFLGY	26-1591GSFLBK	121	94	30
26-1591DSBK	26-1591DSGY	26-1591DFLBK	26-1591DFLGY	26-1591DSFLBK	150	80	46
26-1591HSBK	26-1591HSGY	26-1591HFLBK	26-1591HFLGY	26-1591HSFLBK	165	71	25
26-1591ESBK	26-1591ESGY	26-1591EFLBK	26-1591EFLGY	26-1591ESFLBK	191	11	57

## Hammond Multipurpose Boxes

### Hammond Multipurpose Flanged Base Boxes - 1591 F2/F2S Series

- Designed for wall or shelf mounting, where the lid can be easily removed with the box insitu, allowing easy access for servicing.
- Splash and dust proof to meet IP54.
- Integral vertical guides for PC cards.
- Individually shrink wrapped for protection.
- Material: Genreal purpose black plastic or flame retardant ABS plastic with a UL94VØ rating.

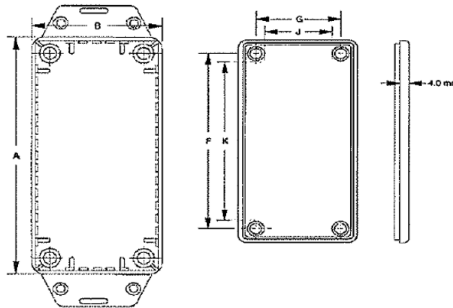
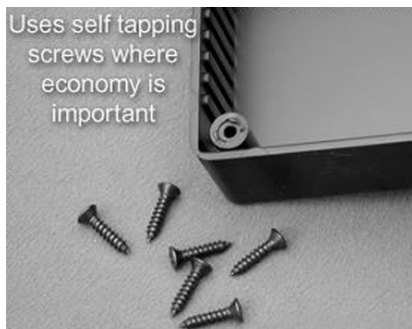

### GP Economy Plastic Boxes

Unit Assembled with black anodized self tapping #4Phillips screws.

### ABS Boxes

Unit assembled with M3 x 10 machine screws into tapped brass inserts.

Clear FR polycarbonate lids available

### Part Numbers:

FR ABS "F2" Series		GP Economical Plastic "F2S" Series		Dimensions (mm)		
Black	Grey	Black	Grey	Length	Width	Height (less lid)
26-159MF2BK	26-1591MF2GY	26-1591MF2SBK	26-1591MF2SGY	85	56	21
26-1591LF2BK	26-1591LF2GY	26-1591LF2SBK	26-1591LF2SGY	85	56	35
26-1591AF2BK	26-1591AF2GY	26-1591AF2SBK	26-1591AF2SGY	100	50	21
26-1591SF2BK	26-1591SF2GY	26-1591SF2SBK	26-1591SF2SGY	110	82	40
26-1591BF2BK	26-1591BF2GY	26-1591BF2SBK	26-1591BF2SGY	112	62	27
26-1591CF2BK	26-1591CF2GY	26-1591CF2SBK	26-1591CF2SGY	120	65	36
26-1591TF2BK	26-1591TF2GY	26-1591TF2SBK	26-1591TF2SGY	120	80	55
26-1591UF2BK	26-1591UF2GY	26-1591UF2SBK	26-1591UF2SGY	120	120	55
26-1591VF2BK	26-1591VF2GY	26-1591VF2SBK	26-1591VF2SGY	120	120	90
26-1591GF2BK	26-1591GF2GY	26-1591GF2SBK	26-1591GF2SGY	121	94	30
26-1591DF2BK	26-1591DF2GY	26-1591DF2SBK	26-1591DF2SGY	150	80	46
26-1591HF2BK	26-1591HF2GY	26-1591HF2SBK	26-1591HF2SGY	165	71	25
26-1591EF2BK	26-1591EF2GY	26-1591EF2SBK	26-1591EF2SGY	191	11	57

## Hammond Hand Held Instrument Boxes - 1593

Designed as electronic instrument enclosure with provision for mounting PCBs.

### Features: Version A

Recessed top for membrane display or pad

Four PCB spacers moulded into bottom half.

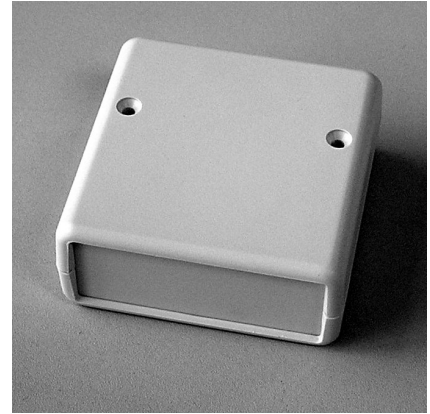
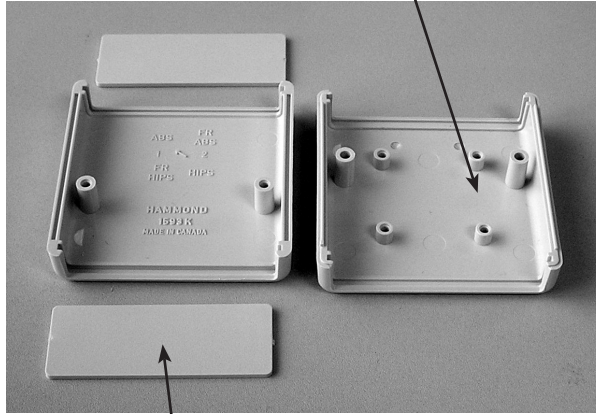
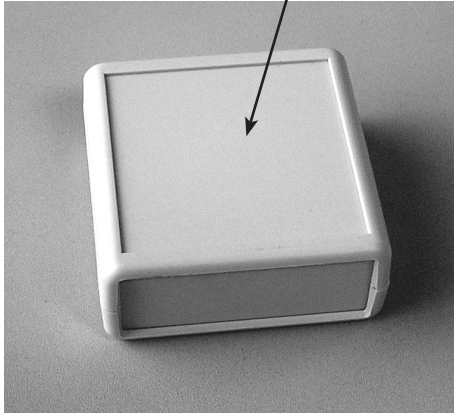

Removable front and rear panels for easy modification - or replace with optional IR panels.

### Features: Version B

Recessed top for membrane display or pad

Four PCB spacers moulded into both halves.

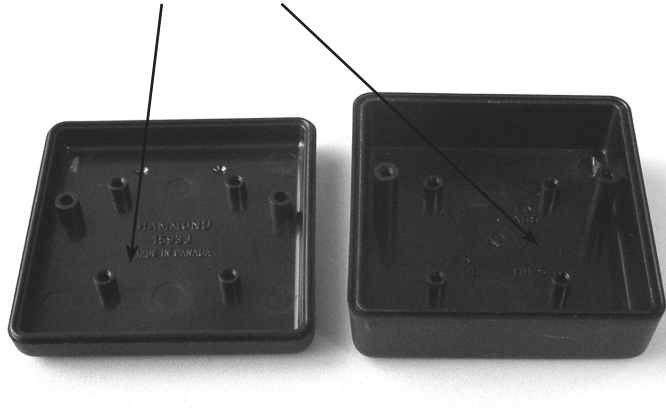
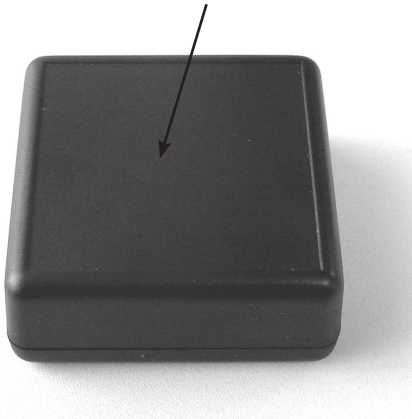

### Features: Version C

Recessed top for membrane display or pad

Four vertical PCB guides moulded in sides.

Long life battery door which snaps in securely

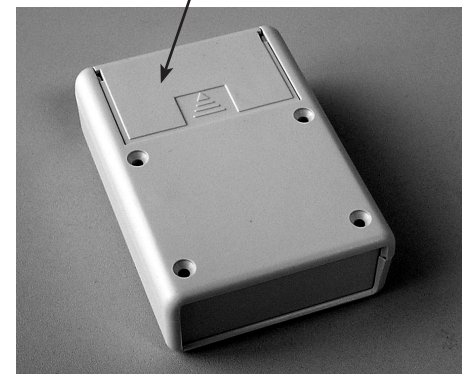
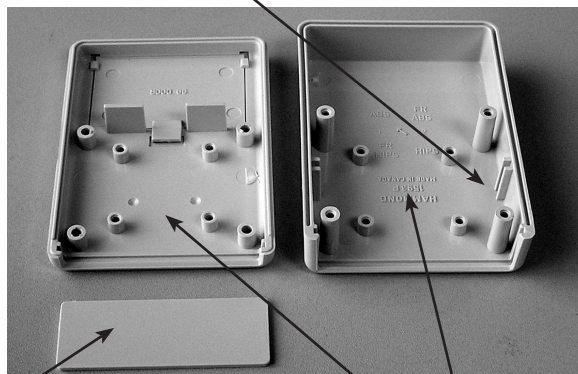
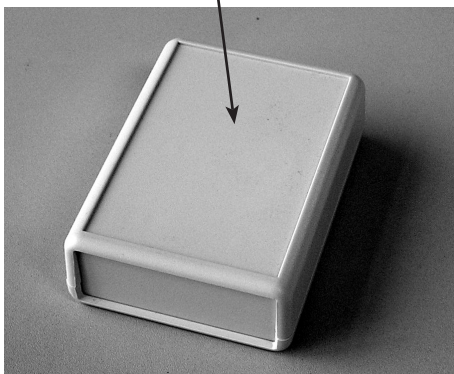

Removable front panel for easy modification or replace with optional IR panels.

Four PCB spacers moulded into both halves.

## "T" Soft Side Enclosure - Hand Held - Flame Retardant ABS Plastic - 1553T Series

Ergonomically designed for a comfortable fit into the user's hand

- Choice of: two sizes, in two versions (with or without battery door) - in two colors (black or grey).
- Perfect for instrument or mobile data enclosures requiring a keypad and display.
- Both the display and keyboard areas are recessed for membrane devices.
- Molded from flame retardant ABS plastic, choice of black (RAL 9011) or grey (RAL 7035) - material carries a UL flammability rating of 94V-0.
- Handheld section of enclosure includes a dark grey (RAL 7012) overmold, soft plastic grip.
- Enclosure is assembled with M3-0.5 x 18 mm Philips machine screws, threaded into integral brass bushings. Perfect for applications when repetitive assembly and disassembly are required.
- Integral brass bushings are factory inserted into top half of the enclosure (see photos).
- Lap joint construction provides protection against access of dust and splashing water. Designed to meet IP54.
- P.C. board standoffs are molded into the case top & bottom halves (see drawings or photos for more details).
- Battery door & compartment version (part numbers ending in "BAT") includes:
  - 1553TT "BAT" versions - 4 battery clips (for 2 - AA batteries) and one 9 volt (PP3) battery clip.
  - 1553T "BAT" versions - 8 battery clips (for 4 - AA batteries) and two 9 volt (PP3) battery clips.
- Contains either one or two end panels (depending on version - see table below) - removable for easy modification.
- Bottom half of enclosure includes molded in label recess on back:
  - 1553TT "BAT" versions - 1.73" x 1.3" (44 mm x 33 mm).
  - 1553T "BAT" versions - 2.2" x 1.65" (56 mm x 42 mm).

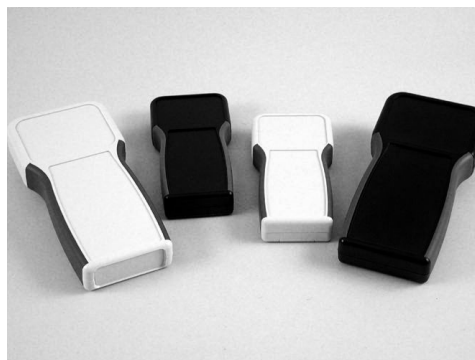

Part Number	Colour	Battery Door & Compartment	Removable Top End Panel	Removable Bottom End Panel	Enclosure Depth mm (Without Lid)			
					Display Section Width	Keyboard Section Width	Length	Enclosure Depth
26-1553TTBK	Black	No	Yes	Yes	80	68	165	28
26-1553TTGY	Grey	No	Yes	Yes	80	68	165	28
26-1553TTBKBAT	Black	Yes: 2 - AA or 1 - 9V	Yes	No	80	68	165	28
26-1553TTGYBAT	Grey	Yes: 2 - AA or 1 - 9V	Yes	No	80	68	165	28
26-1553TBK	Black	No	Yes	Yes	100	85.9	210	32
26-1553TGY	Grey	No	Yes	Yes	100	85.9	210	32
26-1553TBKBAT	Black	Yes: 2 - AA or 1 - 9V	Yes	No	100	85.9	210	32
26-1553TGYBAT	Grey	Yes: 2 - AA or 1 - 9V	Yes	No	100	85.9	210	32

## Hammond Hand Held Instrument Boxes – 1593

Designed as electronic instrument enclosure with provision for mounting PCBs.

- Protection against dust and splashes.
- Comfortable fit in the users hand.
- Box and PCB secured with self tapping screws.
- Optional Infrared panel and Belt or Pocket clip.
- Material: General purpose ABS in Black or Grey.
- 1593NBK and GY are specifically designed for smart card readers.
- Prototype PC Board available.



**Version A**

**Version B**

**Version C**

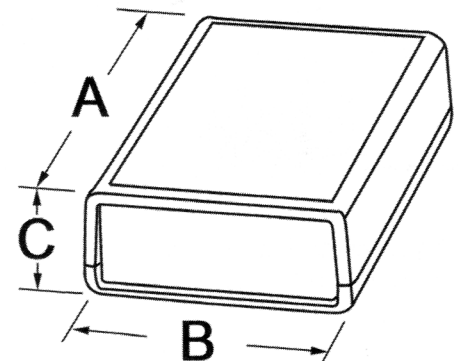
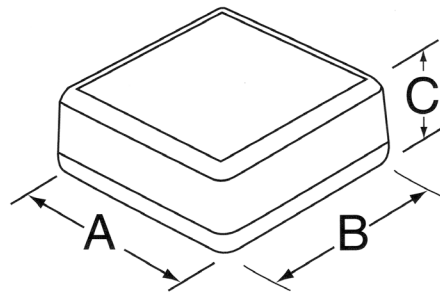
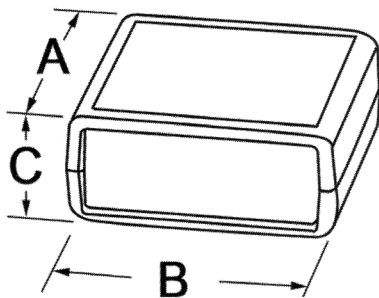

For detailed drawings and CAD files visit [www.hammondmfg.com](http://www.hammondmfg.com).

Part Number Black	Part Number Grey	Part Number Translucent Blue	Length A	Width B	Height C	Version	Battery Door	Removable Panels
26-1593KBK	26-1593KGY	26-1593KTBU	66	66	28	A	No	2
26-1593JBK	26-1593JGY	26-1593JTBU	66	66	28	B	No	0
26-1593SBK	26-1593SGY	26-1593STBU	92	66	21	C	Yes*	1
26-1593LBK	26-1593LGY	26-1593LTBU	92	66	28	A	No	2
26-1593NBK	26-1593NGY	26-1593NTBU	110	75	25	A	No	2
26-1593PBK	26-1593PGY	26-1593PTBU	92	66	28	C	Yes	1
26-1593TBK	26-1593TGY	26-1593TTBU	112	66	21	C	Yes*	1
26-1593QBK	26-1593QGY	26-1593QTBU	112	66	28	C	Yes	1
26-1593DBK	26-1593DGY	26-1593DTBU	114	36	25	A	No	2
26-1593YBK	26-1593YGY	26-1593YTBU	140	66	28	C	Yes	1
26-1593XBK	26-1593XGY	26-1593XTBU	140	66	28	A	No	2

\* AAA batteries are the largest size Models 1593S & 1593T will accept due to its low profile.

## Plastic Enclosures for Development Boards - 1593 HAM Series

Machined from our popular 1593 series plastic enclosures.

- Machined to accept popular development boards - choose from the Arduino Uno, Arduino Due, Arduino Mega 2560, beaglebone, beaglebone black, freescale freedom KL-05Z, freescale freedom KL-02Z or freescale freedom KL-25Z.
- Molded in a choice of black, grey or Translucent Blue general purpose ABS plastic with a satin texture.
- Enclosure is machined to allow access to I/O connectors & often used controls and/or LEDs
- Enclosure is secured with self tapping screws.
- Black & Translucent Blue plastic enclosures include black screws, grey plastic enclosures include nickel finish screws.
- Includes four (4) self adhesive rubber feet & instruction sheet.
- **Development boards are NOT included.**

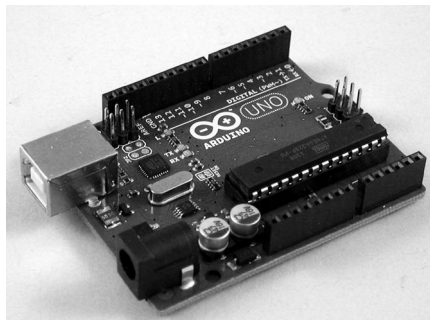

Part Number	Colour	Use With	Removable Panel	Length	Width	Enclosure Depth (assembled)	Original Enclosure Used
26-1593HAMUNOBK	Black	Arduino Uno	2 (Front & Rear)	110	75	25	1593Nxx
26-1593HAMUNOGY	Grey						
26-1593HAMUNOTBU	Translucent Blue						
26-1593HAMDUEBK	Black	Arduino Due	2 (Front & Rear)	110	75	25	1593Nxx
26-1593HAMDUEGY	Grey						
26-1593HAMDUETBU	Translucent Blue						
26-1593HAMMEGABK	Black	Arduino Mega 2560	2 (Front & Rear)	110	75	25	1593Nxx
26-1593HAMMEGAGY	Grey						
26-1593HAMMEGATBU	Translucent Blue						
26-1593HAMDOGBK	Black	Beaglebone	2 (Front & Rear)	95	77	30	-
26-1593HAMDOGGY	Grey						
26-1593HAMDOGTBU	Translucent Blue						
26-1593HAMBONEBK	Black	Beaglebone Black	2 (Front & Rear)	95	77	30	-
26-1593HAMBONEBGY	Grey						
26-1593HAMBONETBU	Translucent Blue						
26-1593HAMFREE1BK	Black	Freescale Freedom FRDM-KL02Z & FRDM-KL05Z	2 (Front & Rear)	92	66	28	1593Lxx
26-1593HAMFREE1GY	Grey						
26-1593HAMFREE1TBU	Translucent Blue						
26-1593HAMFREE2BK	Black	Freescale Freedom FRDM-KL25Z	2 (Front & Rear)	92	66	28	1593Lxx
26-1593HAMFREE2GY	Grey						
26-1593HAMFREE2TBU	Translucent Blue						

### Thick Wall RFI - Conductive Plastic Enclosures - 1594 RFI Series

Designed for EMI/RFI shielding applications - using conductive plastic (a compound of plastic and stainless steel fibers).

- For shielding effectiveness reports see “recommended reading” section at [www.hammondmfg.com](http://www.hammondmfg.com)
- Electronic instrument enclosures, ideally suited for mounting printed circuit boards.
- Thick wall design with an average wall thickness of .13” (3.3 mm).
- Molded from a compound of stainless steel fibers and flame retardant ABS plastic (carries a UL flammability rating of 94V-0).
- Designed to meet IP54.
- NOTE: Material is brittle - acts like phenolic - NOT FOR HIGH IMPACT USE.
- Countersunk lid is secured with four M3 x 0.5 - 0.71” (18 mm) long, Philips machine screws threaded into integral brass bushings. Perfect for applications with repetitive assembly and disassembly are required.
- Black with matte textured finish.

Part Number	Colour	Overall Enclosure Dimensions		Enclosure Depth (Less Lid)
		Length	Width	
26-1594RFIABK	Black	56	56	28
26-1594RFIBBK	Black	81	56	28
26-1594RFICBK	Black	105	66	33
26-1594RFIDBK	Black	131	66	43
26-1594RFIEBK	Black	167	107	53

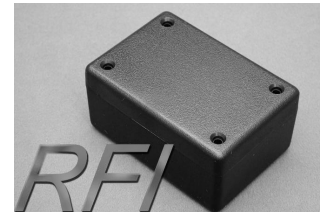

### RFI - Hand Held Enclosures Conductive Plastic - 1599 RFI Series

Designed for EMI/RFI shielding applications - using conductive plastic (a compound of plastic and stainless steel fibers).

- For shielding effectiveness reports see “recommended reading” section at [www.hammondmfg.com](http://www.hammondmfg.com)
- Attractively styled and ergonomically designed for use as a “hand-held” instrument enclosure.
- Molded from a compound of stainless steel fibers and flame retardant ABS plastic (material carries a UL flammability rating of 94V-0).
- Recessed top for membrane display or pad.
- Lap joint construction provides protection against dust accumulation and splashing water.
- Extra deep top and ultra shallow base are specifically designed to enhance the aesthetics of the enclosure and provide the user with flexibility and assembly efficiency.
- Designed to meet IP54.
- NOTE: Material is brittle - acts like phenolic - NOT FOR HIGH IMPACT USE.
- Lid is secured with Philips machine screws, threaded into tapped integral brass bushings. Perfect for applications with repetitive assembly and disassembly are required.

Part Number	Colour	Battery Door	Overall Enclosure Dimensions		Enclosure Depth (Less Lid)
			Length	Width	
26-1599RFIBBK	Black	No	130	65	25
26-1599RFIBBKBAT	Black	Yes	130	65	25
26-1599RFIEBK	Black	No	170	85	34
26-1599RFIEBKBAT	Black	Yes	170	85	34
26-1599RFIHBK	Black	No	220	110	44
26-1599RFIHBKBAT	Black	Yes	220	110	44
26-1599RFIKBK	Black	No	220	140	40.5
26-1599RFIKBKBAT	Black	Yes	220	140	40.5





## Hammond Economy / FRABS Heavy Duty Boxes - 1594/S/W

Rugged electronic instrument enclosure with provision for mounting PCBs.

- Splash and dust proof box designed for IP54.
- Available in black or grey with matte textured finish.
- Individually shrink wrapped for protection.
- Material: Economy Plastic or flame retardant ABS plastic with a UL flammability rating of 94-V0
- Also available in Black and Grey.
- Watertight version meets IP65—WBK and WGY
- Average wall thickness of 3.3mm.

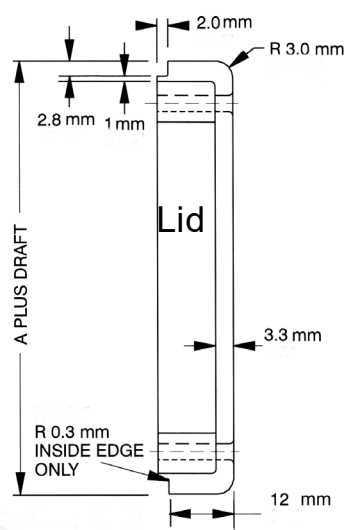
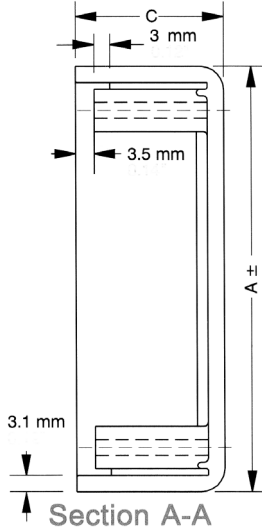
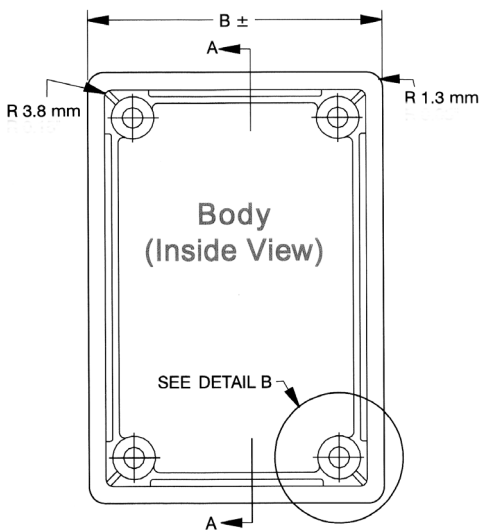

For detailed drawings & CAD files visit website: [www.hammondmfg.com](http://www.hammondmfg.com)

Detail B Typical 4 corners

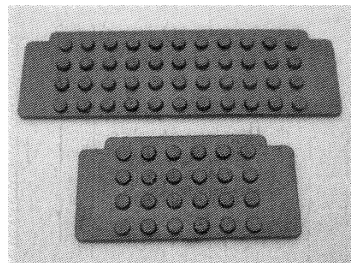
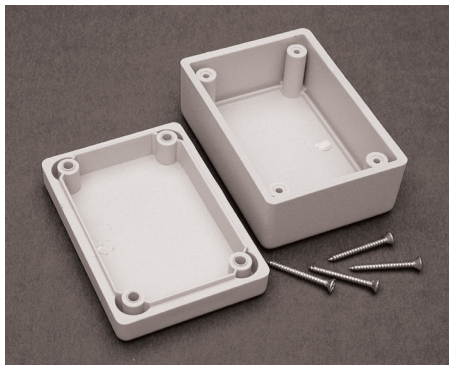
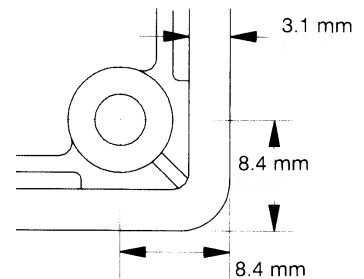

**PCB Adaptors** available to allow for vertical or horizontal mounting of PC board .

### Economy Plastic Boxes

Unit assembled with black anodized countersunk self tapping #4 x 25mm Phillips screws.

### ABS Boxes

Unit assembled with M3 x 20 Phillips countersunk machine screws into tapped brass inserts.

Part Number			Length A	Width B	Height C Base	Height including Lid
Black/Grey Economic Plastic	Black/Grey FR ABS	Black/ Grey FR Watertight Version				
26-1594ASBK/GY	26-1594ABK/GY	26-1594AWBK/GY	56	56	28	40
26-1594BSBK/GY	26-1594BBK/GY	26-1594BWBK/GY	81	56	28	40
26-1594CSBK/GY	26-1594CBK/GY	26-1594CWBK/GY	105	66	33	45
26-1594DSBK/GY	26-1594DBK/GY	26-1594DWBK/GY	131	66	43	55
26-1594ESBK/GY	26-1594EBK/GY	26-1594EWBK/GY	167	107	53	65

## Hammond Sloping ABS Console Boxes - 1595

Desk top electronic instrument enclosure with provision for mounting PCBs.

- Two piece construction. Integral card guides accept 1.5mmP.C. Cards. 0.20" diameter stand off bosses in the base for supporting various subassemblies.
- Available in black or grey with matte textured finish.
- Integral brass bushings with four M3 x 0.5" x 8 mm Philips pan head screw hold recessed panel into sloping front of case.
- 1.01mm aluminium panel with paper on one side
- Case Material: Flame retardant ABS plastic with a UL flammability rating of 94-V0
- Four self-adhesive feet included.

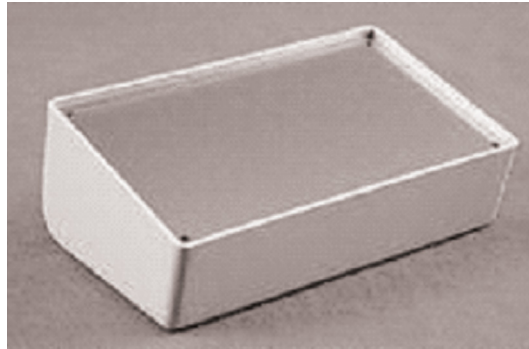
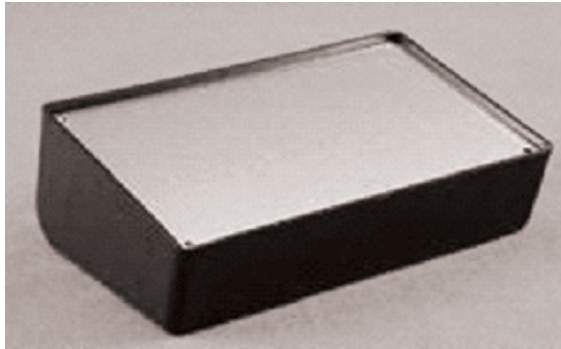

For detailed drawings & CAD files visit website [www.hammondmfg.com](http://www.hammondmfg.com)

Part Number		Length	Width	Height (Back of console)
Black	Grey			
26-1595CBK	26-1595CGY	96	161	58
26-1595EBK	26-1595EGY	130	215	75

## Hammond Potting Boxes – 1596

Moulded from black general purpose ABS plastic

- One piece moulded construction.
- Temperature rated -20°C to +94°C
- 1.0mm wall thickness.
- Wide range of sizes to suit many applications.

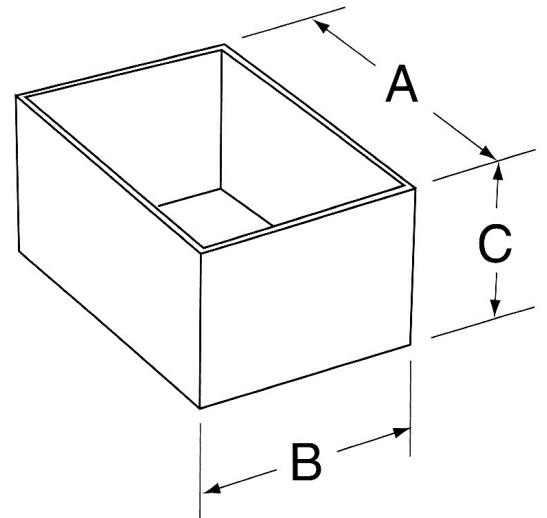
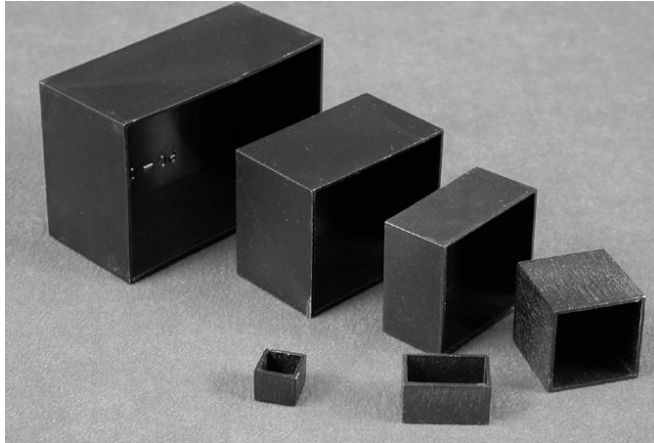

Part Number	Length A	Width B	Depth C
26-1596B109	12	12	9
26-1596B110	22	14	12
26-1596B101	25	20	15
26-1596B112	25	25	25
26-1596B102	30	20	15
26-1596B111	30	30	20
26-1596B103	40	35	20
26-1596B107	40	40	20
26-1596B113	40	40	29
26-1596B104	50	40	30
26-1596B108	50	50	30
26-1596B105	75	50	35
26-1596B114	75	75	40
26-1596B115	89	64	32.5
26-1596B106	100	50	25

## Hammond Takachi Boxes – 1597

Moulded from black or grey general purpose ABS plastic

- Unique rounded side - two piece moulded construction.
- Top & bottom “snap together.”
- Includes molded in keyhole knockout areas for mounting either vertically or horizontally.
- Bottom half includes 6 molded in P.C. board standoffs.



26-1597CBK



26-1597DGY



26-1597X

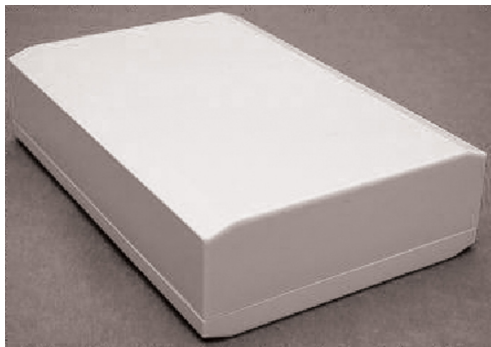

26-1597Y

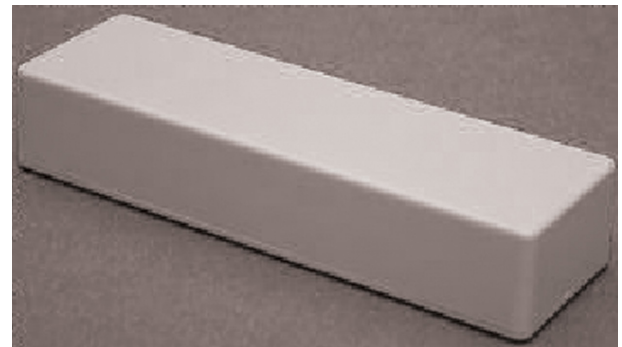
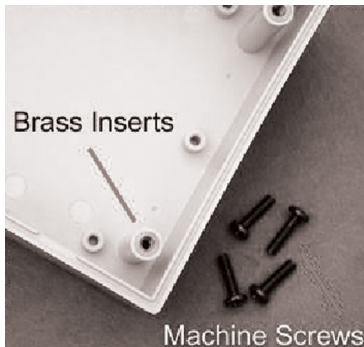

26-1597V

Part Number		Length	Width	Depth (Including Lid)
Black	Grey			
26-1597CBK	26-1597CGY	140	110	35
	26-1597DGY	180	125	35
	26-1597X	140	90	45
	26-1597Y	200	135	50
	26-1597V	130	40	25

## Hammond Desktop Instrument Boxes

Designed as electronic instrument enclosures with provision for mounting PCBs.

- **1598** - FRABS with aluminum end panels
- **1598S** - Economical version with aluminum end panels
- **1598SP** - Economical version with plastic end panels
- Integral horizontal PCB mounts on Eurocard centres and vertical card guides.
- Brushed aluminium front & back panels. Optional black ABS panels.
- SP series has black ABS and panels.
- Designed to meet IP54.
- Material: Flame retardant Black or Grey ABS or Grey general purpose ABS.
- FRABS boxes have brass bushings for assembly. General purpose boxes use self taper screws.
- EMI/RFI shielded cases are available in black.

Moulded in PCB spacers and vertical card guides

Tongue & groove construction requires only two assembly screws.

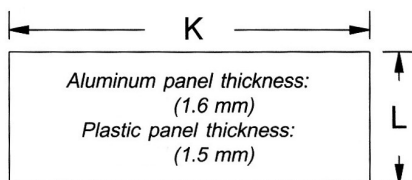
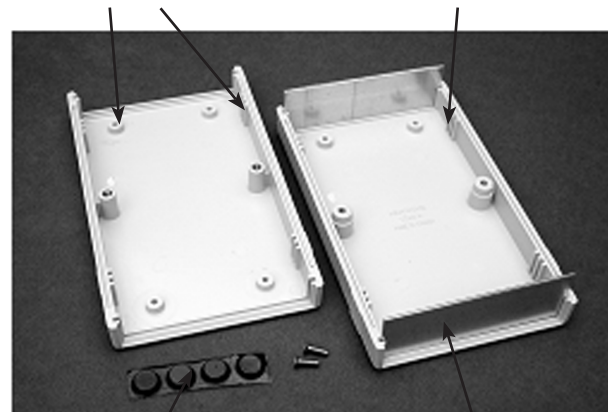
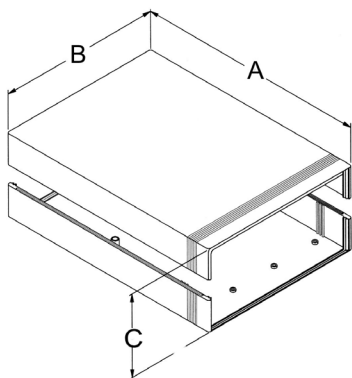

Front or Rear Panel

Complete with rubber feet and hardware.

Easy to modify black ABS or strong aluminium end panels.

Part Number				A	B	C	K	L
Black FR ABS	Grey FR ABS	"S" Series Grey	"SP" Series Grey					
26-1598BBK	26-1598BGY	26-1598BSGY	26-1598BSGYPBK	134	135	50	128	45
26-1598ABK	26-1598AGY	26-1598ASGY	26-1598ASGYPBK	157	94	36	86	27
26-1598EBK	26-1598EGY	26-1598ESGY	26-1598ESGYPBK	160	160	86	152	79
26-1598BBBK	26-1598BBGY	26-1598BBSGY	26-1598BBSGYPBK	179	154	36	146	29
26-1598CBK	26-1598CGY	26-1598CSGY	26-1598CSGYPBK	180	155	52	145	46
26-1598DBK	26-1598DGY	26-1598DSGY	26-1598DSGYPBK	180	206	64	198	58
26-1598FBK	26-1598FGY	26-1598FSGY	26-1598FSGYPBK	250	160	40	152	35
26-1598GBK	26-1598GGY	26-1598GSGY	26-1598GSGYPBK	250	160	76	152	69
26-1598HBK	26-1598HGY	26-1598HSGY	26-1598HSGYPBK	280	200	40	192	35
26-1598JBK	26-1598JGY	26-1598JSGY	26-1598JSGYPBK	280	200	76	192	69

## Tablet Enclosures - Hand Held - Flame Retardant ABS Plastic - 1599TAB Series

Ergonomically designed for a comfortable fit into the user's hand

- Low profile - ergonomically designed for a comfortable fit into the user's hands.
- Perfect for instrument or mobile data enclosures requiring a touch screen.
- Choice of two sizes - both available with or without battery compartment.
- Molded from flame retardant ABS plastic, choice of black (RAL 9011) or grey (RAL 7035) - material carries a UL flammability rating of 94V-0.
- Enclosure is assembled with six (6) - M3-0.5 x 18 mm Philips machine screws, threaded into integral brass bushings. Perfect for applications when repetitive assembly and disassembly are required.
- Integral brass bushings are factory inserted into the top half of the enclosure (see photos).
- Lap joint construction provides protection against access of dust and splashing water. Designed to meet IP54.
- P.C. board standoffs are molded into case top & bottom halves (see drawings or photos for more details).
- Battery door & compartment version (part numbers ending in "BAT") includes 8 battery clips (for 4 - AA batteries) and two 9 volt (PP3) battery clips.
- Contains one end panel - removable for easy modification.
- Bottom half of enclosure includes a square - molded inlay for labels



Part Number	Colour	Battery Door & Compartment	Removable Top End Panel	Overall Enclosure Dimensions		
				Length	Width	Enclosure Depth
26-1599TABMBK	Black	No	No	170	135	27
26-1599TABMGY	Grey	No	No	170	135	27
26-1599TABMBKBAT	Black	Yes	Yes	170	135	27
26-1599TABMGYBAT	Grey	Yes	Yes	170	135	27
26-1599TABLBK	Black	No	No	240	190	30
26-1599TABLGY	Grey	No	No	240	190	30
26-1599TABLBKBAT	Black	Yes	Yes	240	190	30
26-1599TABLGYBAT	Grey	Yes	Yes	240	190	30

## Hammond Hand Held Boxes - 1599 / 1599S

Designed for use as a "hand-held" instrument enclosures

- Lap joint construction provides protection against dust and splashes.
- Designed to meet IP54.
- Extra deep top and ultra shallow base provide the user with flexibility.
- Two keyhole knockouts to facilitate wall mounting installation.
- FRABS boxes have M3 screws and brass bushings for assembly.
- Economy boxes use self tapping screws.
- Battery Doors options available.
- Material: Flame retardant Black or Grey ABS or Economy Plastic.



For detailed drawings, CAD files and colour photos visit [www.hammondmfg.com](http://www.hammondmfg.com)

### Fire Retardant UL94V0 ABS version

The FRABS boxes are assembled with M3 x 10mm machine screws and integral brass inserts.

### Economy Plastic version

Same features as for the ABS version but moulded in economical plastic. Perfect where economy is important and where repetitive assembly and disassembly is not vital. These boxes use #4 x 5/8" self tapping screws for assembly.

Part Number			Battery Door	Dimensions (Base only)		
Black FRABS	Grey FRABS	Grey Economic Plastic		Length	Width	Height (Incl Lid)
26-1599BBK	26-1599BGY	26-1599BSGY	No	130	65	25
26-1599BBKBAT	26-1599BGYBAT	26-1599BSGYBAT	Yes	130	65	25
26-1599BBKCP	26-1599BGYCP	-	No	130	65	25
26-1599BBKBATCP	26-1599BGYBATCP	-	Yes	130	65	25
26-1599EBK	26-1599EGY	26-1599ESGY	No	170	85	34
26-1599EBKBAT	26-1599EGYBAT	26-1599ESGYBAT	Yes	170	85	34
26-1599HBK	26-1599HGY	26-1599HSGY	No	220	110	44
26-1599HBKBAT	26-1599HGYBAT	26-1599HSGYBAT	Yes	220	110	44
26-1599KBK	26-1599KGY	26-1599KSGY	No	220	140	40.5
26-1599KBKBAT	26-1599KGYBAT	26-1599KSGYBAT	Yes	220	140	40.5

## Hammond Short Slope Desktop Instrument Boxes – 1599T / 1599TS

Designed as electronic instrument enclosures with provision for mounting PCBs.

- Two piece lap joint construction provides protection against dust and splashes.
- Designed to meet IP54.
- Integral horizontal PCB mounts.
- ABS boxes have brass bushings for assembly.
- Economy Plastic boxes use self tapping screws.
- Material: Flame retardant Black or Grey ABS or Grey economy plastic

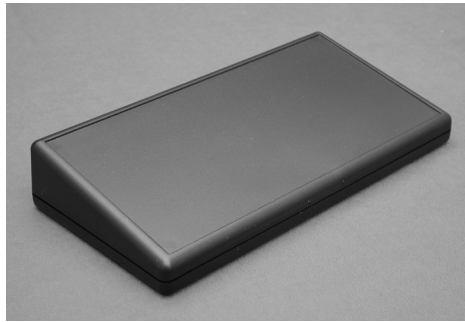

For detailed drawings, CAD files and colour photos visit [www.hammondmfg.com](http://www.hammondmfg.com)

### Fire Retardant UL94V0 ABS version 1599T

Part Number		Rear Panel	PCB Bush		Dimensions (Includes Lid)			
Black FRABS	Grey FRABS		Base	Top	Width	Length	Height (Rear)	Height (Front)
26-1599ETSBK	26-1599ETSGY	1	6	-	85	170	34.1	18.6
26-1599HTSBK	26-1599HTSGY	2	6	-	110	220	40	19
26-1599KTSBK	26-1599KTSGY	2	8	8	140	220	46.5	20.7

The ABS boxes have brass bushings and assembled with M3 x 10mm machine screws.

### Economy Plastic version 1599TS

Same features as for the ABS version but moulded in economical plastic. Perfect where economy is important and where repetitive assembly and disassembly is not vital. These boxes use #4 x 5/8" self tapping screws for assembly.

Part Number	Rear Panel	PCB Bush		Dimensions (Includes Lid)			
Grey Economy Plastic		Base	Top	Width	Length	Height (Rear)	Height (Front)
26-1599ESTSGY	1	6	-	85	170	34.1	18.6
26-1599HSTSGY	2	6	-	110	220	40	19
26-1599KTSSGY	2	8	8	140	220	46.5	20.7



## Hammond Long Slope Desktop Instrument Boxes - 1599 TL /

Designed as electronic instrument enclosures with provision for mounting PCBs.

- Two piece lap joint construction provides protection against dust and splashes.
- Designed to meet IP54.
- Integral horizontal PCB mounts.
- ABS boxes have brass bushings for assembly.
- Economy plastic boxes use self tapping screws.
- Rear of unit contains 1 removable panel (refer website for details).
- Battery door option available.
- Material: Flame retardant Black or Grey ABS or Grey economy plastic.

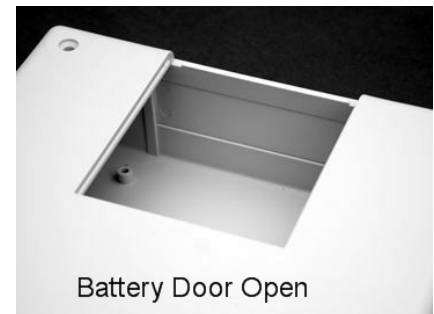

For detailed drawings, CAD files and colour photos visit [www.hammondmfg.com](http://www.hammondmfg.com)

### Fire Retardant UL94V0 ABS version 1599TL

The ABS boxes are assembled with M3 x 10mm machine screws.

Part Number		Battery Door	PCB Bush		Dimensions (Base Only)			
Black FRABS	Grey FRABS		Base	Top	Width	Length	Height (Rear)	Height (Front)
26-1599KTLBK	26-1599KTLGY	-	8	8	140	220	40.5	18
26-1599KTLBKBAT	26-1599KTLGYBAT	Yes	8	8	140	220	40.5	18

### Economy Plastic version 1599STL

Same features as for the ABS version but moulded in economy plastic.

Perfect where economy is important and where repetitive assembly and disassembly is not vital. These boxes use #4 x 5/8" self tapping screws for assembly.

Part Number	Battery Door	Rear Panel	PCB Bush		Dimensions (Base Only)			
Black FRABS			Base	Top	Width	Length	Height (Rear)	Height (Front)
26-1599KSTLGY	-	1	8	8	140	220	40.5	18
26-1599KSTLGYBAT	Yes	1	8	8	140	220	40.5	18

### NEMA Polyester Enclosures - PJ Series

Continuous hinge door with twist/snap latches

Available to order, please refer to Hammond website for sizes and specification sheets: [www.hammondmfg.com](http://www.hammondmfg.com)

- For use as instrument enclosures, electric, hydraulic or pneumatic control housings, electrical junction boxes or terminal wiring enclosures.
- Provides insulation and protection where equipment may be wet or hosed down.
- Ideal for applications with high temperature or corrosive environments.
- Moulded in fibreglass polyester
- Enhanced UV inhibitors
- Operating temperatures between 130°C and -40°C (266°F to -40°F).



## Hammond RITEC– Hand Held Boxes - RH Series

Designed as a “hand-held” electronic instrument enclosures, suited for mounting P.C.B.

- Lap joint construction provides protection against dust and splashes.
- Designed to meet IP54.
- Removable front panel for easy modifications.
- RH3115 and RH3135 use self tapping screws.
- Assembled with M3 Philips machine screws, threaded into integral brass bushings.
- Both top and bottom halves contain P.C. board standoffs molded in.
- The two largest sizes include four self adhesive rubber feet for desk top use.
- Enclosures with battery door are available in - gasketed (IP65rated) & ungasketed.
- Material: Molded in a light grey general purpose ABS plastic with a light texture.
- Optional IR and Panels available.

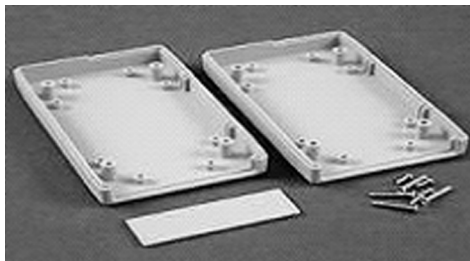
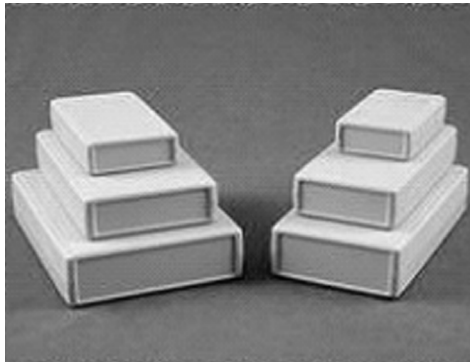

Part Number	Dimensions (Base Only)			
	Grey ABS	Length	Width	Height (Assembled)
26-RH3115		100	60	25
26-RH3135		120	70	25
26-RH3155		165	80	32
26-RH3165		165	100	32
26-RH3185		185	135	40
26-RH3195		190	100	40

For detailed drawings, CAD files and colour photos visit [www.hammondmfg.com](http://www.hammondmfg.com)

## Hand Held with Battery Door Enclosure

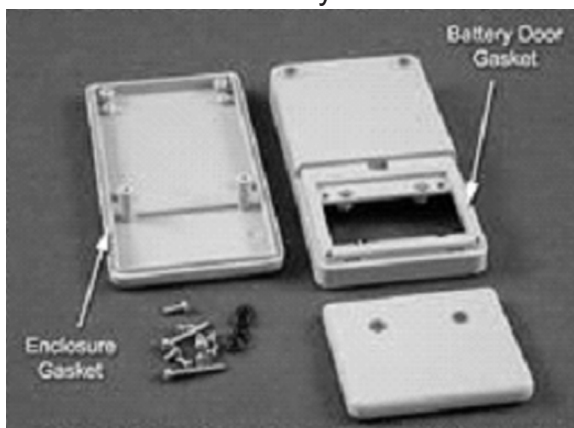

Part Number		Dimensions (Base Only)		
Ungasketed Grey	With Gaskets Grey IP65	Length	Width	Height (Assembled)
26-RH3015	26-RH3005	130	68	25
26-RH3055	26-RH3045	120	70	30



## Hammond RITEC - Hand Held and Flanged Lid Deep Lid/Shallow Lid Boxes - RL Series

Designed to house P.C. Boards

- Two part - snap action - clam shell construction. Both halves include smooth recessed area for membrane, label or silkscreen.
- Designed to meet IP54.
- P.C. board standoffs are molded into both halves of the enclosure.
- P.C. board guides molded into top half of deep lid types.
- Material: Molded in a light grey general purpose ABS plastic with a light texture.

### Shallow Lid



### Deep Lid

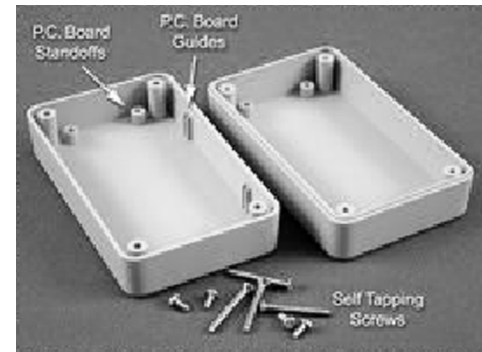
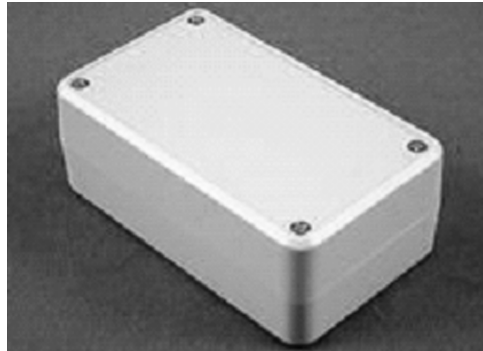

For detailed drawings, CAD files and colour photos visit [www.hammondmfg.com](http://www.hammondmfg.com)

### Shallow Lid

Part Number		Dimensions		
Grey	With Flanged Lid	Length	Width	Height (With Lid)
26-RL6105	26-RL6105-F	80	60	30
26-RL6115	26-RL6115-F	80	60	40
26-RL6215	26-RL6215-F	125	80	35
26-RL6225	26-RL6225-F	125	80	50
26-RL6335	26-RL6335-F	125	100	60
26-RL6365	26-RL6365-F	125	100	90
26-RL6435	26-RL6435-F	150	100	60
26-RL6465	26-RL6465-F	150	100	90
26-RL6555	26-RL6555-F	175	125	70
26-RL6585	26-RL6585-F	175	125	100
26-RL6655	26-RL6655-F	200	150	70
26-RL6685	26-RL6685-F	200	150	100

### Deep Lid

Part Number	Dimensions (Base Only)		
Grey ABS	Length	Width	Height (With Lid)
26-RL6015	104	65	40
26-RL6035	114	65	40
26-RL6055	178	105	40
26-RL6065	205	105	40

## Hammond RITEC – ABS Plastic Instrument Boxes - RM Series

Designed to house P.C. Boards - for hand-held use

Two part - clam shell construction. Bottom half includes molded in standoffs for easy P. C. Board installation.

Designed to meet IP43 .

Front & rear panels are interchangeable and easily removable for modification.

Includes two (or four) - assembly screws (depending on size).

Material: Molded in a light grey general purpose ABS plastic with a light texture.

Options include replacement IR translucent or aluminum panels.

**Assembled view Top**



**Open view**

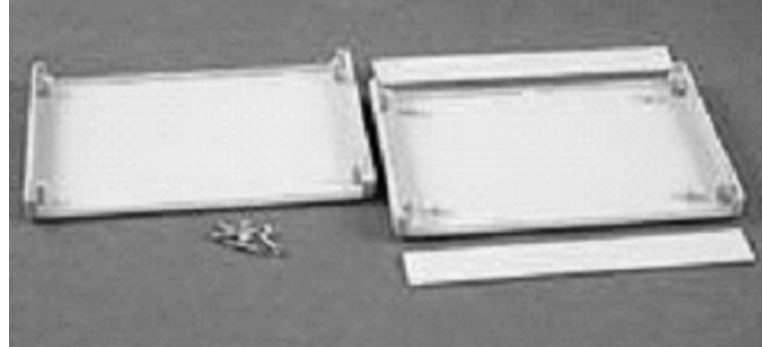

For detailed drawings, CAD files and colour photos visit [www.hammondmfg.com](http://www.hammondmfg.com)

Part Number	Dimensions			
	Grey	Length	Width	Height (Assembled)
26-RM2015S		130	100	30
26-RM2015M		130	100	50
26-RM2015L		130	100	70
26-RM2055S		190	140	30
26-RM2055M		190	140	50
26-RM2055L		190	140	70
26-RM2095S		250	180	50
26-RM2095M		250	180	75
26-RM2095L		250	180	100

## Hammond RITEC– Watertight Boxes — RP Series

Ideally suited for mounting printed circuit boards or DIN rail mounted components.

- Bottom half includes moulded in standoffs for easy PCB installation, and DIN rail mounted components.
- Internal DIN rail tabs are moulded in.
- Designed to meet IP65.
- Gasketed lid with two piece construction protects against oil, dust and water.
- Rubber gasket is included and must be field installed.
- Lid is secured with self captivated - M3.5 stainless steel machine screws threaded into integral stainless steel bushings.
- Material: Molded in a light grey general purpose ABS or polycarbonate ABS is available with a clear polycarbonate Lid.

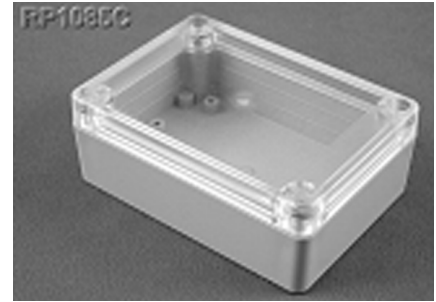
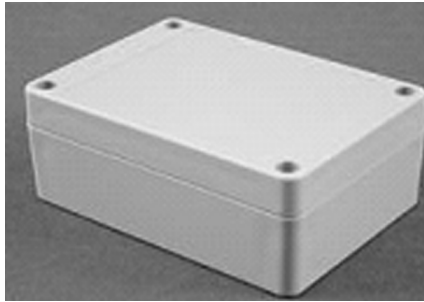

Part Number			Dimensions (Base Only)		
ABS (Grey)	ABS Grey (Clear Lid)	Polycarbonate Grey	Width	Length	Height (With Lid)
26-RP1025	26-RP1025C	26-RP1020	60	65	40
26-RP1065	26-RP1065C	26-RP1060	80	85	55
26-RP1085	26-RP1085C	26-1RP080	75	105	40
26-RP1095	26-RP1095C	26-RP1090	75	105	55
26-RP1135	26-RP1135C	26-RP1130	85	125	55
26-RP1205	26-RP1205C	26-RP1200	105	145	40
26-RP1215	26-RP1215C	26-RP1210	105	145	60
26-RP1175	26-RP1175C	26-RP1170	85	165	55
26-RP1245	26-RP1245C	26-RP1240	125	165	75
26-RP1285	26-RP1285C	26-RP1280	146	186	75
26-RP1455	26-RP1455C	26-RP1450	165	220	60
26-RP1465	26-RP1465C	26-RP1460	165	220	85

### Optional Mounting Feet

26-MF0045



26-MF0055

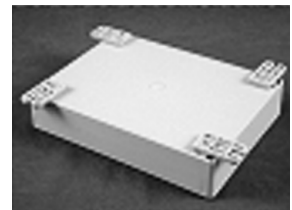

Part Number	Use with enclosures part number
26-MF0045	26-RP1025 - 26RP1285 or 26-RP1025C - 26-RP1285C
26-MF0055	26-RP1455 - 26-RP1456 or 26-RP1455C - 26-RP1465C

For detailed drawings, CAD files and colour photos visit [www.hammondmfg.com](http://www.hammondmfg.com)

## Hammond RITEC – Watertight - Deep Lid Boxes - RP Series

Ideally suited for mounting printed circuit boards or DIN rail mounted components.

- Bottom half includes moulded in standoffs for easy P.C.B. installation and DIN rail mounted components.
- Internal DIN rail tabs are moulded in.
- Designed to meet IP65.
- Gasketed lid with two piece construction protects against oil, dust and water.
- Rubber gasket is included and must be field installed.
- Lid is secured with self captivating - M3.5 stainless steel machine screws threaded into integral stainless steel bushings.
- Material: Molded in a light grey general purpose ABS plastic.
- Also available with a clear polycarbonate lid.

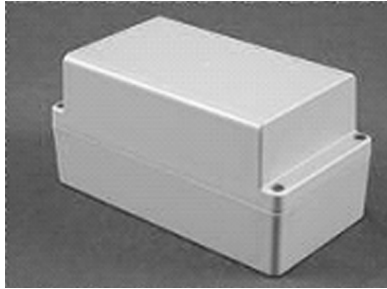

Assembled view ABS Top



Clear polycarbonate lid

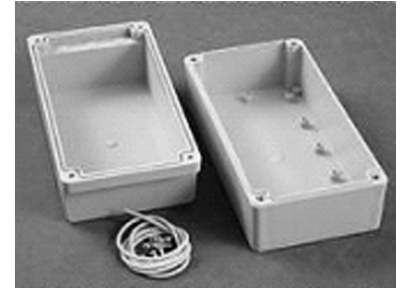

Open view ABS

Part Number			Dimensions		
ABS (Grey)	Polycarbonate Grey	ABS with Clear Lid	Length	Width	Height (With Lid)
26-RP1155	26-RP1150	26-RP1155C	125	85	85
26-RP1185	26-RP1180	26-RP1185C	165	80	85
26-RP1385	26-RP11380	26-RP1385C	186	146	110

For detailed drawings, CAD files and colour photos visit [www.hammondmfg.com](http://www.hammondmfg.com)

## Hammond RITEC– Sealed ABS Plastic Boxes - RS Series

Designed to meet IP65.

Part Number	Lid Gasket	Dimensions		
ABS (Grey)		Width	Length	Height (With Lid)
26-RS5105S	Installed	105	105	55
26-RS5305S	Installed	105	165	78
26-RS5705	Kit included	200	250	95
26-RS5805	Kit included	200	250	130



## Hammond Instrument Extruded Aluminium Boxes - 1455 "01" Metal End Panels

Available in clear or black anodized.

- Rugged extruded aluminium body.
- Designed for equipment interfacing.
- PCB slide into extruded internal slots.
- Metal end version includes two aluminium end panels and two black plastic bezels.
- Extruded body includes a slide removable "belly" plate - except in smaller "A", "B" and "C" size.
- Hardware and self adhesive rubber feet included.
- Coloured end bezels available. Custom length assemblies available - minimum quantity may apply.



Part Number		Length	Width	Height
Clear	Black			
26-1455C801	26-1455C801BK	80	54	23
26-1455C1201	26-1455C1201BK	120	54	23
26-1455J1201	26-1455J1201BK	120	78	27
26-1455K1201	26-1455K1201BK	120	78	43
26-1455L1201	26-1455L1201BK	120	103	30.5
26-1455N1201	26-1455N1201BK	160	103	53
26-1455J1601	26-1455J1601BK	160	78	27
26-1455K1601	26-1455K1601BK	160	78	43
26-1455L1601	26-1455L1601BK	160	103	30.5
26-1455P1601	26-1455P1601BK	160	125	30.5
26-1455Q1601	26-1455Q1601BK	160	125	51.5
26-1455R1601	26-1455R1601BK	160	165	30.5
26-1455T1601	26-1455T1601BK	160	165	51.5
26-1455L2201	26-1455L2201BK	220	103	30.5
26-1455N2201	26-1455N2201BK	220	103	53
26-1455P2201	26-1455P2201BK	220	125	30.5
26-1455Q2201	26-1455Q2201BK	220	125	51.5
26-1455R2201	26-1455R2201BK	220	165	30.5
26-1455T2201	26-1455T2201BK	220	165	51.5

## Hammond Instrument Extruded Aluminium Boxes - 1455 "02" Plastic End Panels

- Plastic end version contains two easy to machine black solid plastic end panels. Panels are one piece with integral bezel.
- Extruded body includes a slide removable "belly" plate - except in smaller "A", "B" and "C" size.
- Smaller sizes (A & B) are rounded for better hand held ergonomics.
- PCB boards mount in slots in the extrusion.
- Coloured plastic ends available.
- Custom length assemblies available—minimum quantity may apply.

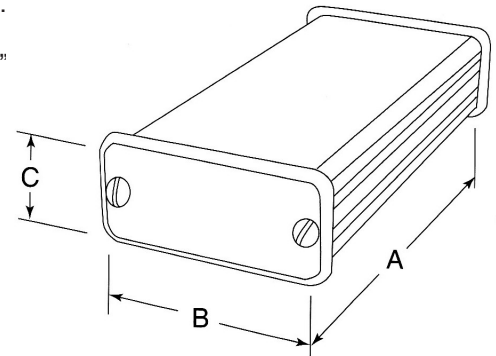

Part Number - Plastic End Version		Length A	Width B	Height C
Clear	Black			
26-1455A802	26-1455A802BK	80	70	12
26-1455B802	26-1455B802BK	80	71.7	19
26-1455C802	26-1455C802BK	80	54	23
26-1455A1002	26-1455A1002BK	100	70	12
26-1455B1002	26-1455B1002BK	100	71.7	19
26-1455A1202	26-1455A1202BK	120	70	12
26-1455B1202	26-1455B1202BK	120	71.7	19
26-1455C1202	26-1455C1202BK	120	54	23
26-1455J1202	26-1455J1202BK	120	78	27
26-1455K1202	26-1455K1202BK	120	78	43
26-1455L1202	26-1455L1202BK	120	103	30.5
26-1455N1202	26-1455N1202BK	120	103	53
26-1455J1602	26-1455J1602BK	160	78	27
26-1455K1602	26-1455K1602BK	160	78	43
26-1455L1602	26-1455L1602BK	160	103	30.5
26-1455N1602	26-1455N1602BK	160	103	53
26-1455P1602	26-1455P1602BK	160	125	30.5
26-1455Q1602	26-1455Q1602BK	160	125	51.5
26-1455R1602	26-1455R1602BK	160	165	30.5
26-1455T1602	26-1455T1602BK	160	165	51.5
26-1455L2202	26-1455L2202BK	220	103	30.5
26-1455N2202	26-1455N2202BK	220	103	53
26-1455P2202	26-1455P2202BK	220	125	30.5
26-1455Q2202	26-1455Q2202BK	220	125	51.5
26-1455R2202	26-1455R2202BK	220	165	30.5
26-1455T2202	26-1455T2202BK	220	165	51.5



## Extruded Aluminium Enclosures - Channel Mount - 1455 NC Series

Designed to house P.C. boards or equipment - for easy enclosure mounting to aluminum channel.

- Two versions to choose from (open bezel with metal endplates OR solid ABS plastic bezel).
- Sized for P.C. boards with 92mm (min.) to 98mm (max.) width. Enclosures will not accept & were not designed for 100mm wide eurocard.
- P.C. boards mount horizontally by sliding into internal slots extruded into the enclosure body.
- Rugged one piece body - constructed from extruded aluminum with a minimum thickness of .09" (2.29 mm).
- Extruded body & aluminum endplates (on metal endplate version) are clear anodized.
- Open bezel - metal endplate version includes eight (8) clear zinc plated assembly screws. NOTE: Recommended screw torque is 5 lbf/in
- Solid bezel version includes eight (8) black assembly screws. NOTE: Recommended screw torque is 5 lbf/in.



Open Bezel With Metal Endplate Version

Solid ABS Plastic Bezel Version

Part Number	Overall Enclosure Dimensions		
	Length	Width	Height
26-1455NC1201	120	103	53
26-1455NC1601	160	103	53
26-1455NC2201	220	103	53

Part Number	Overall Enclosure Dimensions		
	Length	Width	Height
26-1455NC1202	120	103	53
26-1455NC1602	160	103	53
26-1455NC2202	220	103	53

## Channel Mounting Kits

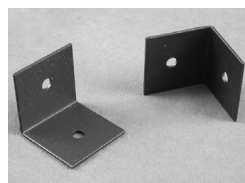

### 26-1455NCFL -

Flanged brackets (sold in pairs).



### 26-1455TBOLT -

Quantity two (2) - 8mm X 20 "T" bolts, washers & hex nut.

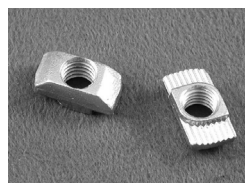

### 26-1455TNUT -

Quantity two (2) - 8mm "T" nuts

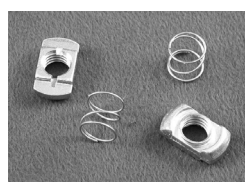

### 26-1455TSNUT -

Quantity two (2) - 8mm "T" nuts & springs

## Wallmount Extruded Aluminium Enclosures - 1455 ZT Series

Designed to house electronics for equipment interfacing where shelf or wall mounting is required.

- Consists of an aluminum “U” shaped extrusion body and a slide-in flat aluminum bottom plate.
- Slide-in plate perfect for easy mounting of components.
- Steel foot “L” brackets are attached to each end. “L” brackets are punched with 0.31” (7.9 mm) diameter keyholes for easy mounting of enclosure.
- Rugged body constructed from extruded aluminum with a minimum thickness of .06” (1.5 mm).
- Available in either clear or black anodized finish, the bottom slide-in plate is finished to match.
- The two end “L” brackets are matched to the enclosure.
- Includes all assembly hardware.
- NOTE: Recommended screw torque is 5 lbf/in

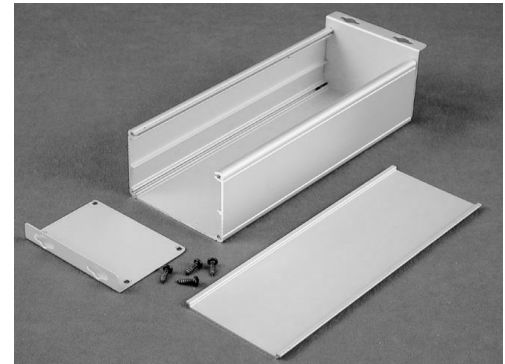
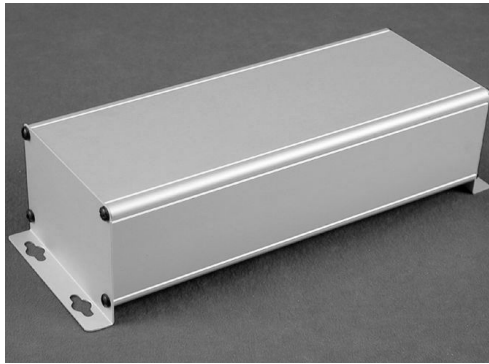

Part Number	Anodized Color	Overall Enclosure Dimensions		
		Length	Width	Height
26-1455ZT1601	Clear	160	88.9	56
26-1455ZT1601BK	Black	160	88.9	56
26-1455ZT2201	Clear	220	88.9	56
26-1455ZT2201BK	Black	220	88.9	56

## Extruded Aluminium Enclosures ROLEC mobileCASE - R250 Series

Designed to house P.C. boards (not included) or equipment for mobile use

- Modern and ergonomic design
- Sized for standard Eurocards
- P.C. boards mount horizontally by sliding into internal slots extruded into the enclosure body
- Internal height 1.06" (27mm)
- Rugged body constructed from extruded aluminum with diecast aluminum ends
- Extruded aluminum is powder paint coated in a silver metallic finish
- Diecast ends (see accessories below) are black (RAL9005) powder paint coated
- Choice of two versions - one piece closed or two piece "clam shell"
- One piece version is rated to IP 65 (with gasketed end plates below)
- Two piece version is rated to IP 54 (with gasketed end plates below)



Diecast End Plates Attached  
(Assembled View)



Example Application  
(Assembled View)



With P.C. Board Mounted  
(Two piece version)

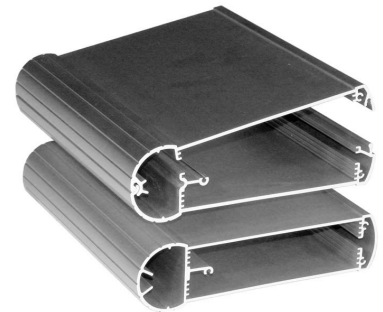

R250 Series Top

R250 Series Bottom

Part Number	Version	Overall Enclosure Dimensions		
		Length (L)	Width (W)	Profile Width (P)
26-R250-080-120	One Piece	120	118	80
26-R251-080-120	Two Piece	120	118	80
26-R250-080-160	One Piece	160	118	80
26-R251-080-160	Two Piece	160	118	80
26-R250-100-160	One Piece	160	138	100
26-R251-100-160	Two Piece	160	138	100
26-R250-100-200	One Piece	200	138	100
26-R251-100-200	Two Piece	200	138	100
26-R250-130-180	One Piece	180	168	130
26-R251-130-180	Two Piece	180	168	130
26-R250-130-240	One Piece	240	168	130
26-R251-130-240	Two Piece	240	168	130

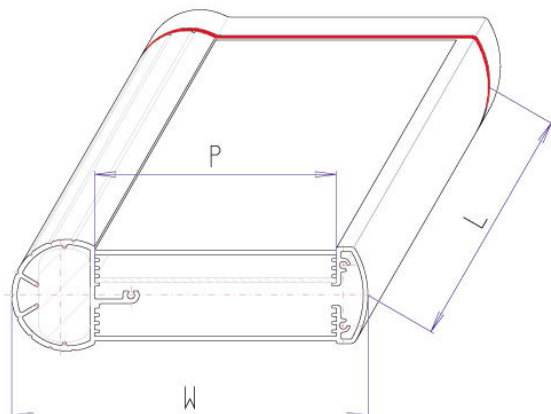

## Hammond Extruded Aluminium Instrument Boxes 1455 Accessory Flange Kits

Available in clear or black anodized.

Part Number - Flange Kit		Use with Series
Clear Anodized	Black Anodized	
26-1455CF	26-1455CFBK	26-1455C
26-1455JF	26-1455JFBK	26-1455J
26-1455KF	26-1455KFBK	26-1455K
26-1455LF	26-1455LFBK	26-1455L
26-1455NF	26-1455NFBK	26-1455N
26-1455PF	26-1455PFBK	26-1455P
26-1455QF	26-1455QFBK	26-1455Q
26-1455RF	26-1455RFBK	26-1455R
26-1455TF	26-1455TFBK	26-1455T



## Replacement Parts & Bezel Options



### Closed Bezel

- Red
- Yellow
- Translucent Blue
- Translucent (IR) Red
- Black (Standard)

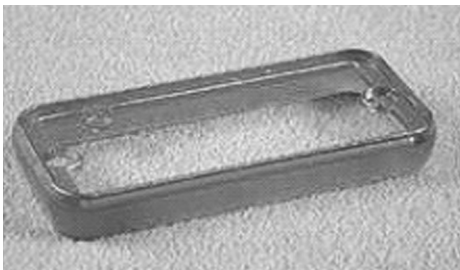

### Open Bezel

- Red
- Yellow
- Translucent Blue
- Translucent (IR) Red
- Black (Standard)

For detailed drawings and CAD files visit [www.hammondmfg.com](http://www.hammondmfg.com)

## Hammond Instrument Extruded Aluminium Boxes - 1457 / 1457E EMI/RFI and IP65 types

Available in clear or black anodized.

- Rugged one piece extruded aluminium body with a recessed area for labels or membrane keypad.
- PCB slide into extruded internal slots. (standard Eurocards)
- Version 1 includes two diecast Al. end panels.
- Version 2 has diecast Al. end panels with mtg flange.
- Hardware and self adhesive rubber feet included.
- 1457E version includes two-end plate EMI/RFI gaskets.

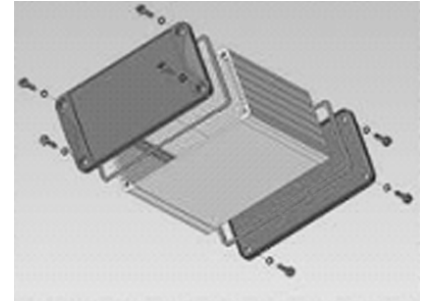
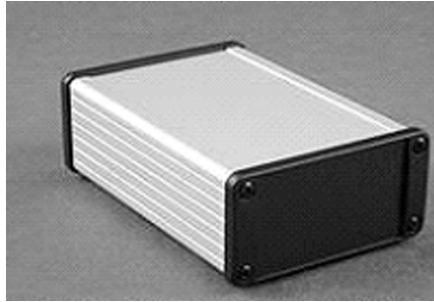

### 1457 Watertight IP 65 - External Dimension

Part Number						
		Flanged Ends				
Clear	Black	Clear	Black	Length	Width	Height
26-1457C801	26-1457C801BK	26-1457C802	26-1457C802BK	80	59	30.9
26-1457C1201	26-1457C1201BK	26-1457C1202	26-1457C1202BK	120	59	30.9
26-1457K1201	26-1457K1201BK	26-1457K1202	26-1457K1202BK	120	84	44.1
26-1457K1601	26-1457K1601BK	26-1457K1602	26-1457K1602BK	160	84	44.1
26-1457N1201	26-1457N1201BK	26-1457N1202	26-1457N1202BK	120	104	54.6
26-1457N1601	26-1457N1601BK	26-1457N1602	26-1457N1602BK	160	104	54.6

### 1457E EMI / RFI Gaskets IP 54 - External Dimension

Part Number						
		Flanged Ends				
Clear	Black	Clear	Black	Length	Width	Height
26-1457C801E	26-1457C801EBK	26-1457C802E	26-1457C802EBK	80	59	30.9
26-1457C1201E	26-1457C1201EBK	26-1457C1202E	26-1457C1202EBK	120	59	30.9
26-1457K1201E	26-1457K1201EBK	26-1457K1202E	26-1457K1202EBK	120	84	44.1
26-1457K1601E	26-1457K1601EBK	26-1457K1602E	26-1457K1602EBK	160	84	44.1
26-1457N1201E	26-1457N1201EBK	26-1457N1202E	26-1457N1202EBK	120	104	54.6
26-1457N1601E	26-1457N1601EBK	26-1457N1602E	26-1457N1602EBK	160	104	54.6

## Hammond Diecast Aluminium General Purpose Boxes-1590

Rugged, diecast aluminium alloy . Tough yet easy to machine. Meets IP54.

- Lap joint construction provides protection against dust & splashing water and improved EMI / RFI shielding.
- Painted version is painted with tough polyester powder paint for lasting finish.
- Assembled with 6-32 x 1/2" nickel plated coloured machine screws to match the finish.
- Watertight versions available — see 1590W type

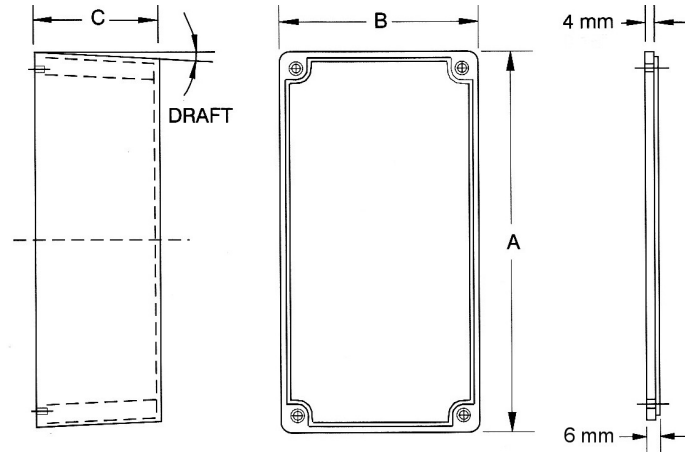

Approx Draft = 1°15' to 2°

For detailed drawings and CAD files visit [www.hammondmfg.com](http://www.hammondmfg.com)

Part Number		Length A	Width B	Height (no lid) C	Height With Lid
Unpainted	Black				
26-1590LLB	26-1590LLBBK	50	50	21	25
26-1590LB	26-1590LBK	51	51	27	31
26-1590H	26-1590HBK	52.5	38	27	31
26-1590Y	26-1590YBK	92	92	38	42
26-1590A	26-1590ABK	93	39	27	31
26-1590G	26-1590GBK	100	50	21	25
26-1590S	26-1590SBK	111	82	40	44
26-1590B	26-1590BBK	112	60	27	31
26-1590BB	26-1590BBBK	119	94	30	34
26-1590Q	26-1590QBK	120	120	28	32
26-1590U	26-1590UBK	120	120	55	59
26-1590V	26-1590VBK	120	120	90	94
26-1590C	26-1590CBK	120	94	53	56.5
26-1590T	26-1590TBK	121	80	55	59
26-1590N1	26-1590N1BK	121.1	66	35.3	39.3
26-1590KK	26-1590KKBK	125	125	53	57
26-1590K	26-1590KBK	125	125	75	79
26-1590J	26-1590JBK	145	95	45	49
26-1590P1	26-1590P1BK	153	82	46	50
26-1590DD	26-1590DDBK	188	119.5	33	37
26-1590D	26-1590DBK	188	120	52	56
26-1590E	26-1590EBK	188	120	78	82
26-1590F	26-1590FBK	188	188	63	67
26-1590R1	26-1590R1BK	192	111	57	61

## Hammond Diecast Aluminium Flanged Base Boxes-1590F

Rugged, diecast aluminium alloy . Tough yet easy to machine. Meets IP54.

- Lap joint construction provides protection against dust & splashing water, and improved EMI / RFI shielding.
- Painted version is painted with tough polyester powder paint for lasting finish.
- Assembled with 6-32 x 1/2" machine screws into tapped holes, nickel plated on black to match the finish.
- Bottom flange is an aluminium plate welded onto the base of the enclosure.
- Lid screws are exposed for easy access. If you require higher security see the flanged lid versions.
- Watertight versions are available — see 1590WF type

For detailed drawings and CAD files visit [www.hammondmfg.com](http://www.hammondmfg.com)



### Standard Version

External Dimensions not including flange

Part Number		Length	Width	Height (no lid)	Height With Lid
Unpainted	Black				
26-1590LLBF	26-1590LLBFBK	50	50	21	25
26-1590LBF	26-1590LBFBK	51	51	27	31
26-1590HF	26-1590HFBK	53	38	27	31
26-1590YF	26-1590YFBK	92	92	38	42
26-1590AF	26-1590AFBK	93	39	27	31
26-1590GF	26-1590GFBK	100	50	21	25
26-1590SF	26-1590SFBK	111	82	40	44
26-1590BF	26-1590BFBK	112	60	27	31
26-1590BBF	26-1590BBFBK	119	94	30	34
26-1590QF	26-1590QFBK	120	120	28	32
26-1590UF	26-1590UFBK	120	120	55	59
26-1590VF	26-1590VFBK	120	120	90	94
26-1590CF	26-1590CFBK	120	94	53	56.5
26-1590TF	26-1590TFBK	121	80	55	59
26-1590N1F	26-1590N1FBK	121.1	66	35.3	39.3
26-1590KKF	26-1590KKFBK	125	125	53	57
26-1590KF	26-1590KFBK	125	125	75	79
26-1590JF	26-1590JFBK	145	95	45	49
26-1590P1F	26-1590P1FBK	153	82	46	50
26-1590DDF	26-1590DDFBK	188	119.5	33	37
26-1590DF	26-1590DFBK	188	120	52	56
26-1590EF	26-1590EFBK	188	120	78	82
26-1590FF	26-1590FFBK	188	188	63	67
26-1590R1F	26-1590R1FBK	192	111	57	61

## Hammond Diecast Aluminium Flanged Lid Boxes-1590FL

Rugged, diecast aluminium alloy . Tough yet easy to machine. Meets IP54.

- Lap joint construction provides protection against dust & splashing water, and improved EMI / RFI shielding.
- Painted version is painted with tough polyester powder paint for lasting finish.
- Assembled with 6-32 x 1/2" machine screws, nickel plated or black to match the finish.
- Flanged lid allows for easy mounting and higher security as the lid screws are hidden. For easier access see the flanged base version.
- Watertight versions are available — see 1590WFL type.

For detailed drawings and CAD files visit [www.hammondmfg.com](http://www.hammondmfg.com)



### Standard Version IP54 External Dimensions

Part Number		Length	Width	Height (no lid)	Height With Lid
Unpainted	Black				
26-1590LBFL	26-1590LBFLBK	51	51	27	31
26-1590AFL	26-1590AFLBK	93	39	27	31
26-1590GFL	26-1590GFLBK	100	50	21	25
26-1590SFL	26-1590SFLBK	111	82	40	44
26-1590BFL	26-1590BFLBK	112	60	27	31
26-1590BBFL	26-1590BBFLBK	119	94	30	34
26-1590QFL	26-1590QFLBK	120	120	28	32
26-1590UFL	26-1590UFLBK	120	120	55	59
26-1590VFL	26-1590VFLBK	120	120	90	94
26-1590CFL	26-1590CFLBK	120	94	53	56.5
26-1590TFL	26-1590TFLBK	121	80	55	59
26-1590N1FL	26-1590N1FLBK	121.1	66	35.3	39.3
26-1590P1FL	26-1590P1FLBK	153	82	46	50
26-1590DDFL	26-1590DDFLBK	188	119.5	33	37
26-1590DFL	26-1590DFLBK	188	120	52	56
26-1590EFL	26-1590EFLBK	188	120	78	82
26-1590FFL	26-1590FFLBK	188	188	63	67
26-1590R1FL	26-1590R1FLBK	192	111	57	61



## Hammond Diecast Aluminium 1590 Series with PCB Card Guides

Rugged, diecast aluminium alloy . Tough yet easy to machine. Meets IP54.

- Lap joint construction provides protection against dust & splashing water, and improved EMI / RFI shielding.
- Painted version is painted with tough polyester powder paint for lasting finish.
- Assembled with 6-32 x 1/2" machine screws, nickel plated or black to match the finish.
- Flanged lid allows for easy mounting and higher security as the lid screws are hidden. For easier access see the flanged base version.
- Watertight versions are available

For detailed drawings and CAD files visit [www.hammondmfg.com](http://www.hammondmfg.com)

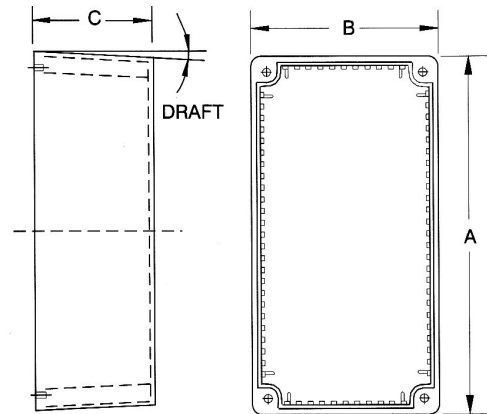
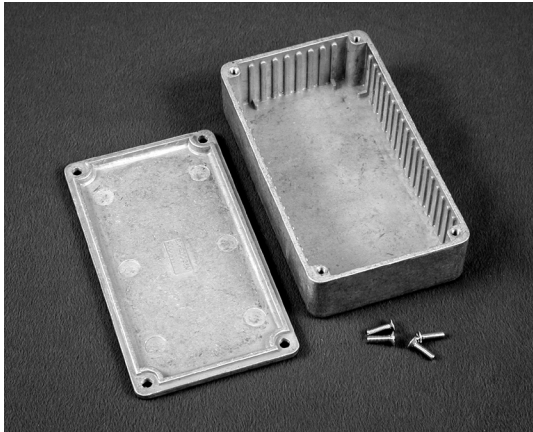

### Standard Version - IP54

Part Number		Length A	Width B	Height (no lid) C	Height (With Lid)
Unpainted	Black				
26-1590L	26-1590LBK	101	50	21	25
26-1590M	26-1590MBK	114	63	27	31
26-1590N	26-1590NBK	121	66	36	40
26-1590P	26-1590PBK	153	82	46	50
26-1590R	26-1590RBK	192	111	57	61

### Flanged Lid Version - IP54 - For easy mounting and higher security

Part Number		Length A	Width B	Height (no lid) C	Height (With Lid)
Unpainted	Black				
26-1590NFL	26-1590NFLBK	121	66	36	40
26-1590PFL	26-1590PFLBK	153	82	46	50

### Flanged Base Version - IP54 - For easy mounting and access

Part Number		Length A	Width B	Height (no lid) C	Height (With Lid)
Unpainted	Black				
26-1590LF	-	101	50	21	25
26-1590MF	-	114	63	27	31
26-1590NF	26-1590NFBK	121	66	36	40
26-1590PF	-	153	82	46	50
26-1590RF	-	192	111	57	61

## Hammond Painted "Stomp Box" - Diecast Aluminium Enclosures - 1590 Series

Designed as electronic instrument enclosures with provision for mounting PCBs.

- Rugged, diecast aluminum alloy (tough - yet easy to machine), electronic instrument enclosure.
- Painted "Stomp Box" versions are coated with a smooth gloss polyester powder paint for a lasting finish, even after machining.
- Smooth paint allows for easy adhesion of labels and/or silk screens.
- Paint colors are matched to standard RAL colours.
- Lap joint construction provides protection against access of dust and splashing water. Also provides for improved EMI/RFI shielding.
- Designed to meet IP54.
- Low side wall draft angle (2 degrees or less) for easy P.C. board mounting.

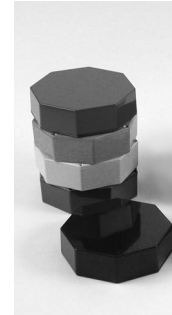

### Rectangular Versions

For detailed drawings, CAD files and colour photos visit [www.hammondmfg.com](http://www.hammondmfg.com)

### Octagonal Versions

### Rectangular Versions

(Also 26-1590XX Series L=145 x W=121 x D=35 - eg. 26-1590XXCB = Cobalt Blue).

Part Number	Colour	RAL Number	Length mm	Width mm	Enclosure Depth mm (Without Lid)
26-1590BCB	Cobalt Blue	RAL 5013	112	60	27
26-1590BGR	Green	RAL 6024	112	60	27
26-1590BLG	Light Gray	RAL 7035	112	60	27
26-1590BOR	Orange	RAL 2009	112	60	27
26-1590BPR	Purple	RAL 4008	112	60	27
26-1590BRD	Red	RAL 3011	112	60	27
26-1590BYL	Yellow	RAL 1021	112	60	27

26-1590BBCB	Cobalt Blue	RAL 5013	119	94	30
26-1590BBGR	Green	RAL 6024	119	94	30
26-1590BBLG	Light Gray	RAL 7035	119	94	30
26-1590BBOR	Orange	RAL 2009	119	94	30
26-1590BBPR	Purple	RAL 4008	119	94	30
26-1590BBRD	Red	RAL 3011	119	94	30
26-1590BBYL	Yellow	RAL 1021	119	94	30

### Octagonal Versions

Part Number	Colour	RAL Number	Length mm	Width mm	Enclosure Depth mm (Without Lid)
26-1590STPCCB	Cobalt Blue	RAL 5013	132.8	132.8	35.2
26-1590STPCGR	Green	RAL 6024	132.8	132.8	35.2
26-1590STPCLG	Light Gray	RAL 7035	132.8	132.8	35.2
26-1590STPCOR	Orange	RAL 2009	132.8	132.8	35.2
26-1590STPCPR	Purple	RAL 4008	132.8	132.8	35.2
26-1590STPCRD	Red	RAL 3011	132.8	132.8	35.2
26-1590STPCYL	Yellow	RAL 1021	132.8	132.8	35.2

## Hammond Painted Octagon & Trapezoid - Diecast Aluminium Enclosures - 1590 Series

Rugged, diecast aluminum alloy (tough - yet easy to machine), electronic instrument enclosure.

- Lap joint construction provides protection against access of dust and splashing water. Also provides for improved EMI/RFI shielding.
- Unpainted version is vibra finished for a smooth surface with no sharp edges.
- Four 6-32 x 1/2" machine screws secure lid - into factory tapped holes.
- Designed to meet IP54.
- Low side wall draft angle (2 degrees or less) for easy P.C. board mounting.



26-1590TRPB



26-1590TRPC

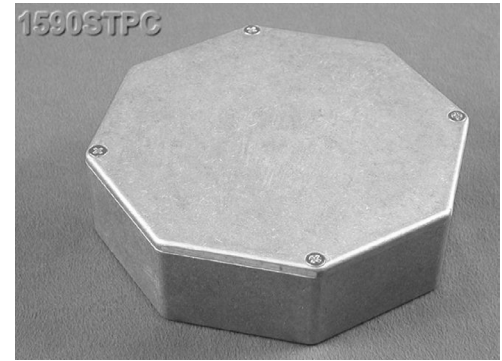

26-1590STPC

Part Number	Colour	Shape	Length mm	Width mm		Enclosure Depth mm (Without Lid)
				Small End	Large End	
26-1590TRPB	Unpainted	Trapezoid	112.0	61.5	79.0	35.2
26-1590TRPBBK	Black	Trapezoid	112.0	61.5	79.0	35.2
26-1590TRPC	Unpainted	Trapezoid	95	121.8	151.0	35.2
26-1590TRPCBK	Black	Trapezoid	95	121.8	151.0	35.2
26-1590STPC	Unpainted	Octagon	132.8	132.8		35.2
26-1590STPCBK	Black	Octagon	132.8	132.8		35.2

## Hammond Zinc Diecast Enclosures - 1590K Series

High impact strength, zinc diecast alloy (tough - yet easy to machine), electronic instrument enclosure.

- Zinc material also offers easy ability to plate the enclosure.
- Zinc material is soft & easy to machine & offers a heavier weight alternative (over double) to our 1590 diecast aluminum enclosures.
- Zinc diecast enclosures provide extra coolness to the touch and add perceived premium quality weight to your product.
- Lap joint construction provides protection against access of dust and splashing water. Also provides for improved EMI/RFI shielding.
- Enclosure is vibra finished for a smooth surface with no sharp edges.
- Designed to meet IP54.
- Low side wall draft angle (2 degrees or less) for easy P.C. board mounting.
- Four (or six in the 1590K432) M3.5 x 0.6 x 12 mm long stainless steel, Philips head, machine screws secure lid - into factory tapped holes.



Part Number	Colour	Length mm	Width mm	Enclosure Depth mm (Without Lid)
26-1590K430	Unpainted	112	62	27
26-1590K431	Unpainted	120	94	52
26-1590K432	Unpainted	188	120	52

## Hammond Eddystone Diecast Aluminium Boxes

Rugged, diecast aluminium alloy . Tough yet easy to machine. Meets IP54.

- Aluminium alloy to BS1490, LM2M - supplied in natural finish
- Eddystone designed, provides excellent EMC performance.
- Lap joint construction provides protection against access of dust and splashing water.
- Lids are retained by 4 - M3.5 x 6 taptite screws.
- Countersunk lid holes, designed to meet IP54.
- Low side wall draft angle (2 degrees or less) for easy P.C. board mounting.



Shallow Lid Version - Thin Wall



Deep Lid Version - Thin Wall

### Shallow Lid Version - Thin Wall

Part Number	Length	Width	Height (no lid)	Height (With Lid)
26-70007	50	50	21	25
26-11451PSLA	52.5	38	27	31
26-27969PSLA	92	38	27	31
26-70009	92	92	38	42
26-27134BPSLA	111	60	12	16
26-27134PSLA	111	60	27	31
26-29830PSLA	120	95	30	34
26-26908PSLA	120	95	53	57
26-11130BPSLA	125	125	12.25	16.25
26-70011	125	125	53	57
26-11130PSLA	125	125	75	79
26-10758PSLA	145	95	45	49
26-26827PSLA	188	120	53	57
26-26357PSLA	188	120	78	82

### Deep Lid Version - Thin Wall

Part Number	Length	Width	Height (no lid)	Height (With Lid)
26-27134BPDLA	111	60	12	35
26-27134PDLA	111	60	27	50
26-29830PDLA	120	95	30	70.2
26-26908PDLA	120	95	53	70.2
26-11130BPDLA	125	125	12.25	52.25
26-11130PDLA	125	125	75	107.2
26-10758PDLA	145	95	45	77.2

## Hammond Diecast Aluminium - 1550 - Light Duty Watertight 1550W

Rugged, diecast aluminium alloy. Tough yet easy to machine.

- Lap joint construction protection against access of dust and splashing water
- Designed to meet IP54. Watertight version 1550W designed to meet IP66.
- 1550W - Lap joint construction with a self-adhesive, EVA foam gasket provides protection against access of dust & water.
- Painted version is painted outside with tough polyester powder paint for lasting finish.(RAL7001)
- Assembled with stainless steel machine screws.
- No internal ribs for easy installation of connectors without interference or additional milling.
- Low side wall draft angle (2 degrees or less) for easy P.C.B mounting.

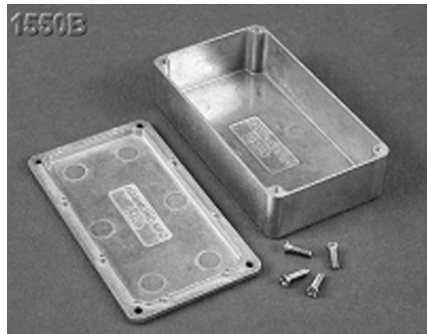
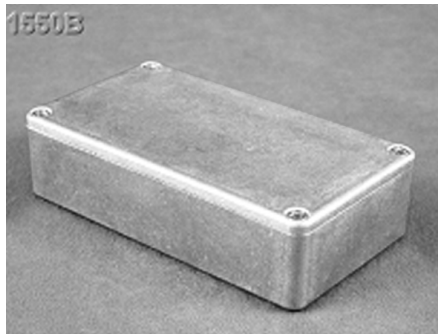

**1550 Series**

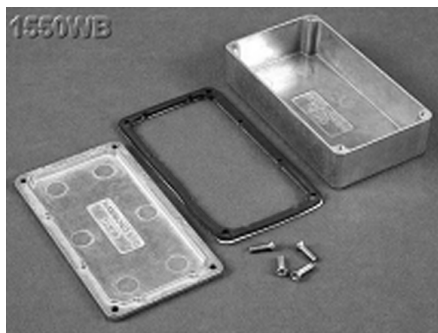

**1550W Series**

For detailed drawings and CAD files visit [ww.hammondmfg.com](http://ww.hammondmfg.com)

Part Number						
1550 Series		1550W Series		Length	Width	Height (No Lid)
Unpainted	Black	Unpainted	Black			
26-1550Q	26-1550QBK	26-1550WQ	26-1550WQBK	60	55	26
26-1550P	26-1550PBK	26-1550WP	26-1550WPBK	80	55	21
26-1550A	26-1550ABK	26-1550WA	26-1550WABK	89	35	26
26-1550B	26-1550BBK	26-1550WB	26-1550WBBK	115	64	26
26-1550D	26-1550DBK	26-1550WD	26-1550WDBK	115	64	51
26-1550C	26-1550CBK	26-1550WC	26-1550WCBK	115	90	51

## Hammond Watertight Diecast Aluminium -1590 W

Rugged, diecast aluminium alloy . Tough yet easy to machine. Meets IP65.

- Lap joint construction with a factory poured silicone rubber gasket around the perimeter provides protection against dust & splashing water.
- Silicone gasket remains flexible from  $-62$  to  $+232^{\circ}\text{C}$
- Assembled with 6-32 x 1/2" stainless steel colour matched machine screws & neoprene 'O' rings.
- Painted version is painted with tough polyester powder paint for a lasting finish.

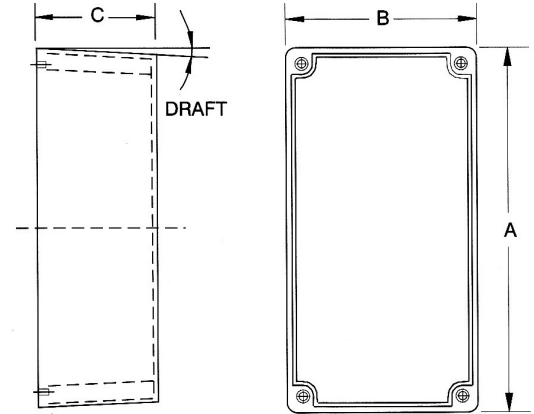

Approx Draft =  $1^{\circ}15'$  to  $2^{\circ}$

For detailed drawings and CAD files visit [www.hammondmfg.com](http://www.hammondmfg.com)

Part Number		Length A	Width B	Height (no lid) C	Height With Lid
Unpainted	Black				
26-1590WLLB	26-1590WLLBBK	50	50	21	25
26-1590WLB	26-1590WLBK	51	51	27	31
26-1590WH	26-1590WHBK	52.5	38	27	31
26-1590WY	26-1590WYBK	92	92	38	42
26-1590WA	26-1590WABK	93	39	27	31
26-1590WG	26-1590WGBK	100	50	21	25
26-1590WS	26-1590WSBK	111	82	40	44
26-1590WB	26-1590WBBK	112	60	27	31
26-1590WBB	26-1590WBBBK	119	94	30	34
26-1590WQ	26-1590WQBK	120	120	28	32
26-1590WU	26-1590WUBK	120	120	55	59
26-1590WV	26-1590WVBK	120	120	90	94
26-1590WC	26-1590WCBK	120	94	53	56.5
26-1590WT	26-1590WTBK	121	80	55	59
26-1590WN1	26-1590WN1BK	121.1	66	35.3	39.3
26-1590WKK	26-1590WKKBK	125	125	53	57
26-1590WK	26-1590WKBK	125	125	75	79
26-1590WJ	26-1590WJBK	145	95	45	49
26-1590WP1	26-1590WP1BK	153	82	46	50
26-1590WDD	26-1590WDDBK	188	119.5	33	37
26-1590WD	26-1590WDBK	188	120	52	56
26-1590WE	26-1590WEBK	188	120	78	82
26-1590WF	26-1590WFBK	188	188	63	67
26-1590WR1	26-1590WR1BK	192	111	57	61

## Hammond Watertight Diecast Aluminium Boxes - Flanged Base — 1590W “F” Series

Rugged, diecast aluminium alloy . Tough yet easy to machine. Meets IP65.

- Lap joint construction with a factory poured of silicone rubber around the perimeter provides protection against dust & splashing water. Silicone gasket remains flexible from -62 to +232°C.
- Painted version is painted with tough polyester powder paint for lasting finish.
- Assembled with 6-32 x 1/2” stainless steel colour matched machine screws & ‘O’ rings.
- Bottom flange is an aluminum plate, welded onto the base of the enclosure.
- Lid screws are exposed for easy access once mounted.

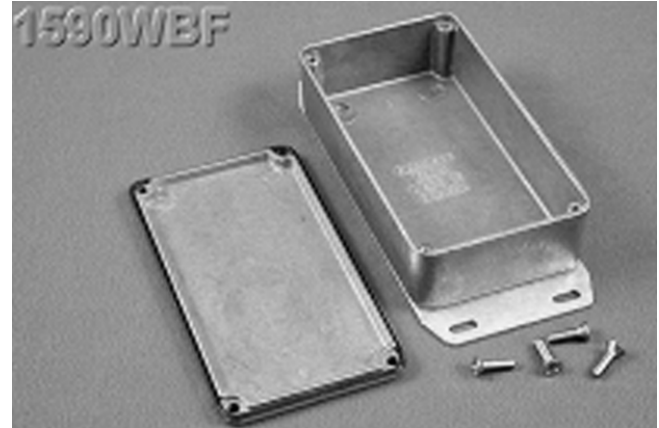
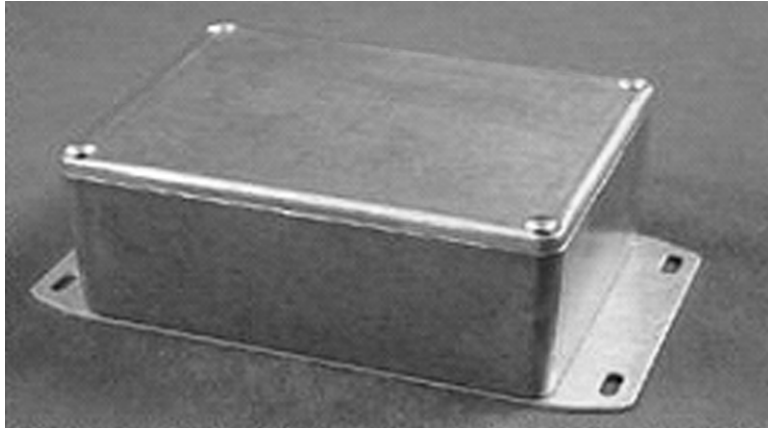

Approx Draft = 1°15' to 2°

For detailed drawings and CAD files visit [ww.hammondmfg.com](http://ww.hammondmfg.com)

Part Number		Length	Width	Height (no lid)	Height With Lid
Unpainted	Black				
26-1590WLLBF	26-1590WLLBFBK	50	50	21	25
26-1590WLBF	26-1590WLBFBK	51	51	27	31
26-1590WHF	26-1590WHFBK	52.5	38	27	31
26-1590WYF	26-1590WYFBK	92	92	38	42
26-1590WAF	26-1590WAFBK	93	39	27	31
26-1590WGF	26-1590WGFBK	100	50	21	25
26-1590WSF	26-1590WSFBK	111	82	40	44
26-1590WBF	26-1590WBFBK	112	60	27	31
26-1590WBBF	26-1590WBBFBK	119	94	30	34
26-1590WQF	26-1590WQFBK	120	120	28	32
26-1590WUF	26-1590WUFBK	120	120	55	59
26-1590WVF	26-1590WVFBK	120	120	90	94
26-1590WCF	26-1590WCFBK	120	94	53	56.5
26-1590WTF	26-1590WTFBK	121	80	55	59
26-1590WN1F	26-1590WN1FBK	121.1	66	35.3	39.3
26-1590WKKF	26-1590WKKFBK	125	125	53	57
26-1590WKF	26-1590WKFBK	125	125	75	79
26-1590WJF	26-1590WJFBK	145	95	45	49
26-1590WP1F	26-1590WP1FBK	153	82	46	50
26-1590WDDF	26-1590WDDFBK	188	119.5	33	37
26-1590WDF	26-1590WDFBK	188	120	52	56
26-1590WEF	26-1590WEFBK	188	120	78	82
26-1590WFF	26-1590WFFBK	188	188	63	67
26-1590WR1F	26-1590WR1FBK	192	111	57	61



## Hammond Watertight Diecast Aluminium Boxes - Flanged Lid — 1590W “FL” Series

Rugged, diecast aluminium alloy . Tough yet easy to machine. Meets IP65.

- Lap joint construction with a factory poured of silicone rubber around the perimeter provides protection against dust & splashing water. Silicone gasket remains flexible from  $-62$  to  $+232^{\circ}\text{C}$ .
- Painted version is painted with tough polyester powder paint for lasting finish.
- Assembled with 6-32 x 1/2” stainless steel colour matched machine screws & ‘O’ rings.
- Flanged lid allows for easy mounting to walls or shelves & provides high security.

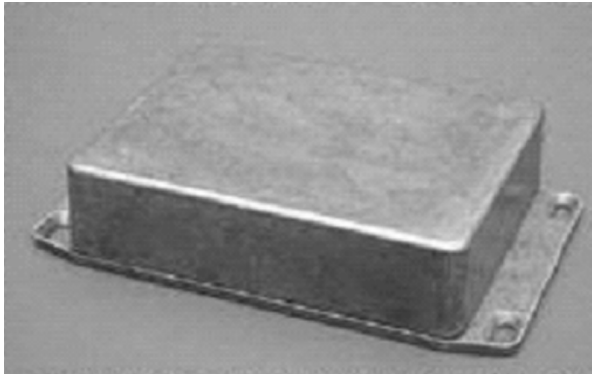

Approx Draft =  $1^{\circ}15'$  to  $2^{\circ}$

For detailed drawings and CAD files visit [ww.hammondmfg.com](http://ww.hammondmfg.com)

Part Number		Length	Width	Height (no lid)	Height With Lid
Unpainted	Black				
26-1590WLBFL	26-1590WLBFLBK	51	51	27	31
26-1590WAFL	26-1590WAFLBK	93	39	27	31
26-1590WGFL	26-1590WGFLBK	100	50	21	25
26-1590WSFL	26-1590WSFLBK	111	82	40	44
26-1590WBFL	26-1590WBFLBK	112	60	27	31
26-1590WBBFL	26-1590WBBFLBK	119	94	30	34
26-1590WQFL	26-1590WQFLBK	120	120	28	32
26-1590WUFL	26-1590WUFLBK	120	120	55	59
26-1590WVFL	26-1590WVFLBK	120	120	90	94
26-1590WCFL	26-1590WCFLBK	120	94	53	56.5
26-1590WTFL	26-1590WTFLBK	121	80	55	59
26-1590WN1FL	26-1590WN1FLBK	121.1	66	35.3	39.3
26-1590WP1FL	26-1590WP1FLBK	153	82	46	50
26-1590WDDFL	26-1590WDDFLBK	188	119.5	33	37
26-1590WDFL	26-1590WDFLBK	188	120	52	56
26-1590WEFL	26-1590WEFLBK	188	120	78	82
26-1590WFFL	26-1590WFFLBK	188	188	63	67
26-1590WR1FL	26-1590WR1FLBK	192	111	57	61

## Hammond Watertight Diecast Aluminium Boxes with PCB Guides - Series 1590W

Rugged, diecast aluminium alloy . Tough yet easy to machine. Meets IP65.

- Integral card guides cast in, accept 1.5mm P.C. cards
- Painted version is painted with tough polyester powder paint for lasting finish.
- Watertight IP65 version has lap joint construction with a factory poured of silicone rubber gasket around the perimeter to provide protection against dust & water.
- Silicone gasket remains flexible from -62 to +232°C.

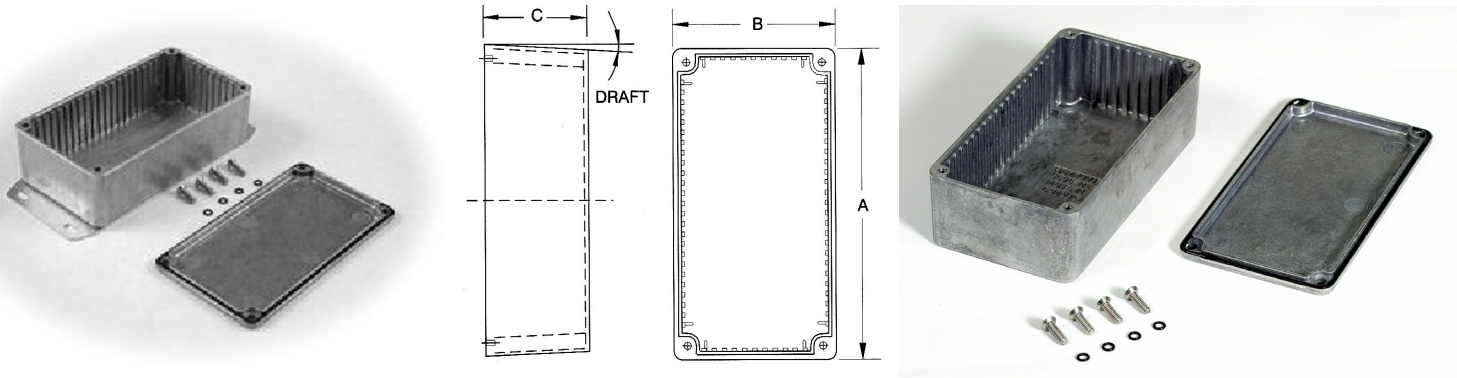

For detailed drawings and CAD files visit [ww.hammondmfg.com](http://ww.hammondmfg.com)

### Standard Version 1590W Series - IP65

Part Number		Length A	Width B	Height (no lid) C	Height With Lid
Unpainted	Black				
26-1590WN	26-1590WNBK	121	66	36	38
26-1590WP	26-1590WPBK	153	82	46	48

### Flanged Lid Version 1590W FL Series - IP65 - For easy mounting and higher security

Part Number		Length A	Width B	Height (no lid) C	Height With Lid
Unpainted	Black				
26-1590WNFL	26-1590WNFLBK	121	66	36	38
26-1590WPFL	26-1590WPFLBK	153	82	46	48

### Flanged Base Version 1590W F Series - IP65 - For easy mounting and access

Part Number		Length A	Width B	Height (no lid) C	Height With Lid
Unpainted	Black				
26-1590WNF	26-1590WNFBK	121	66	36	38
26-1590WPF	26-1590WPFBK	153	82	46	48

## Hammond Watertight , Heavy Duty Thick Wall Diecast Aluminium - 1590Z

Rugged, diecast aluminium alloy . Tough yet easy to machine. Meets IP65.

- Lap joint construction with a one piece silicone rubber gasket provides protection against access of dust & water. Designed to meet IP65.
- Painted version is painted inside and out with tough polyester powder paint for lasting finish.(RAL7001)
- Assembled with stainless steel machine screws and 'O' rings.
- Galvanized steel inner panels available.
- Internal mounting shelf on some models.
- UL and CUL listed certified to NEMA 4X standards (UL508) - File #E65324.
- Easy to wall mount using through box-blind hole on structure outside the gasket.
- For non metallic versions see1590ZGRP.

Natural aluminium with a smooth brushed finish.



Moulded one piece silicon rubber gasket mounts into cast lid groove, compressed by box tongue.

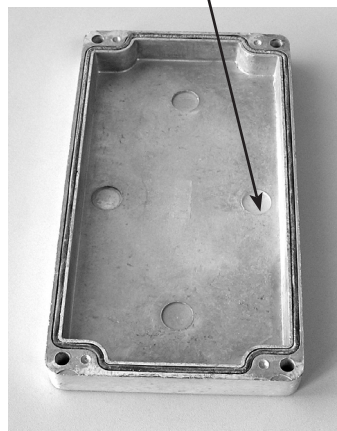

Easy wall mounting using recessed hole outside of gasket protection.

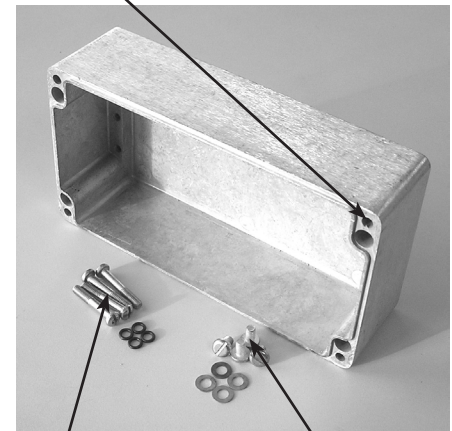

For detailed drawings and CAD files visit [www.hammondmfg.com](http://www.hammondmfg.com)

Stainless steel machine screws into tapped holes with individual neoprene 'O' rings.

Copper ground screws & washers.

Part Number			Length	Width	Height (no lid)	Height (With Lid)
Unpainted	Black	Grey				
26-1590Z060	26-1590Z060BK	26-1590Z060GY	50	45	24	30
26-1590Z061	26-1590Z061BK	26-1590Z061GY	64	58	26	36
26-1590Z100	26-1590Z100BK	26-1590Z100GY	76	80	40	52
26-1590Z110	26-1590Z110BK	26-1590Z110GY	76	80	40	52
26-1590Z062	26-1590Z062BK	26-1590Z062GY	98	64	26	36
26-1590Z119	26-1590Z119BK	26-1590Z119GY	122	120	60	80
26-1590Z120	26-1590Z120BK	26-1590Z120GY	125	80	45	60.5
26-1590Z063	26-1590Z063BK	26-1590Z063GY	150	64	26	36
26-1590Z160	26-1590Z160BK	26-1590Z160GY	160	160	70	90
26-1590Z130	26-1590Z130BK	26-1590Z130GY	176	80	42	54
26-1590Z135	26-1590Z135BK	26-1590Z135GY	176	80	42	62
26-1590Z231	26-1590Z231BK	26-1590Z231GY	200	230	92	112
26-1590Z150	26-1590Z150BK	26-1590Z150GY	221	121	60	80
26-1590Z140	26-1590Z140BK	26-1590Z140GY	250	80	40	55
26-1590Z162	26-1590Z162BK	26-1590Z162GY	260	159	70	90
26-1590Z235	26-1590Z235BK	26-1590Z235GY	335	235	111	131
26-1590Z166	26-1590Z166BK	26-1590Z166GY	360	160	70	90
26-1590Z164	26-1590Z164BK	26-1590Z164GY	361	120	81	101

## Hammond Transformers



### “Classic”— Tube Transformers

- Filament, Plate & Isolation
- Tube Output (Single Ended & Push– Pull)
- Chokes & Reactors
- Replacement Tube Guitar Amp.
- Audiophile ultra-linear



### Audio Transformers

- P. C. Board Mount
- Chassis Mount
- Broadcast Quality
- “Classic” Tube driver & output
- Matching
- Sound distribution
- Miniature potted and pcb types
- Audiophile ultra-linear

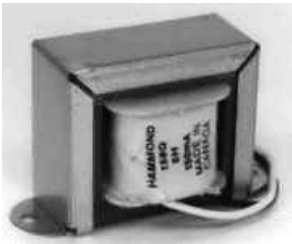

### Chokes & Reactors

- D.C Filter Chokes
- D. C. Reactors
- R. F. Chokes

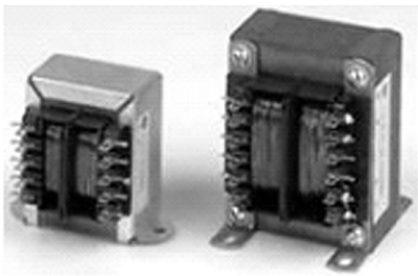

### Power Transformers

- P. C. Board Mount
- Chassis Mount
- Toroidal
- Low & High Voltage



### Pulse Transformers

- P. C. Board Mount
- Chassis Mount



### Instrument Transformers

- Current Transformers
- Potential (Voltage) Transformer

## Other Hammond Enclosures

A wide range of other Hammond enclosures are available.

Refer [www.hammondmfg.com](http://www.hammondmfg.com) for the full range, part numbers and dimensions.

### Rack Mount / Table Top Instrument :

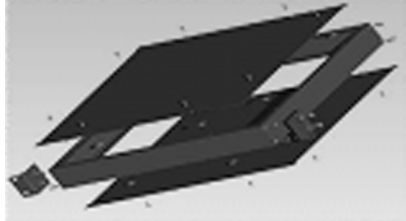

RM-U Series

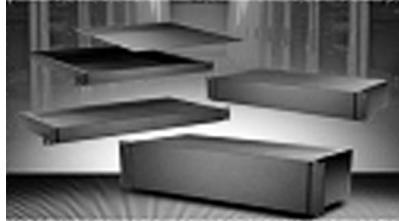

RM-U Series



RMCS/ RMCV Series

### Instrument Enclosures: Utility Cases and Chassis



26-1401 Series (Alum.)



26-1402 Series (Alum.)

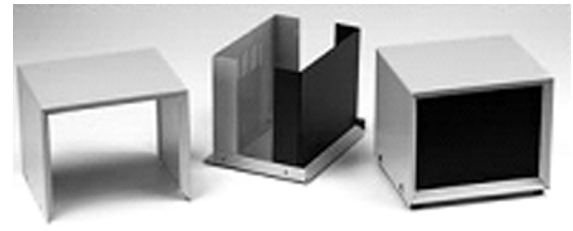

26-1426 Series (Alum. / Steel)

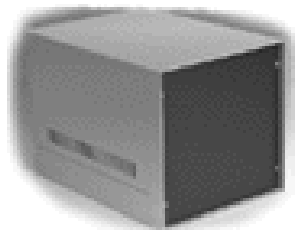

26-1452 Series (Alum. Steel)



26-1454 Series (Steel)

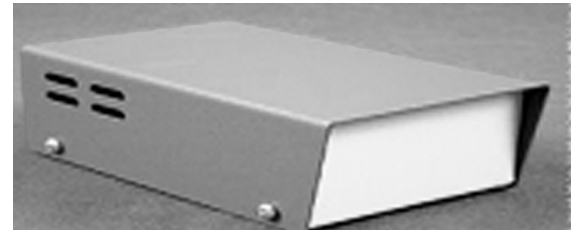

26-511/ 26-513 Series (Steel)



26-518 Series (Module)



26-516 Series (Transformer)

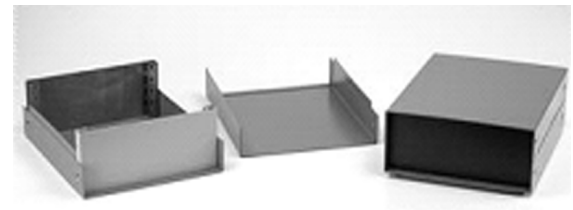

26-1458 Series (Steel)



26-500/515/519 Series (Alum./Steel)

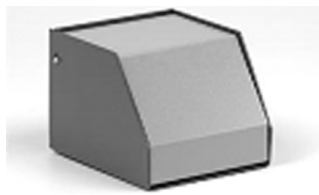

26-SCEM Series (Alum.)

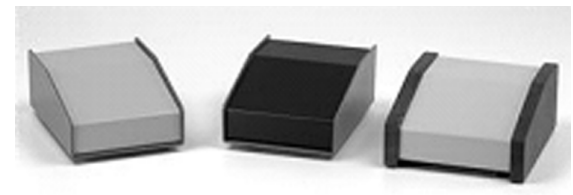

26-1456 Series (Alum.)

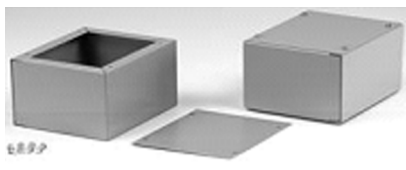

26-1415 Series (Steel)

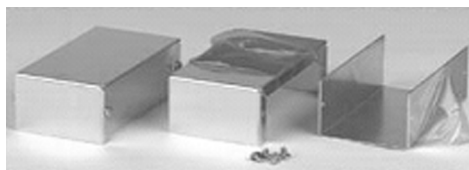

26-1411 /26-1412 Series (Alum. / Steel)



26-1441/26-1431 Steel Chassis

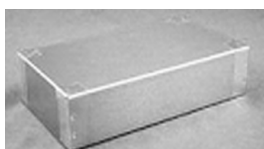

26-1444/1443 Alum. Chassis



26-1451 Perforated Chassis

## Hammond Accessories

A wide range of accessories are available for Hammond enclosures.

Refer [www.hammondmfg.com](http://www.hammondmfg.com) for the full range, part numbers and dimensions.

### Handles: 26-1427 Series



Chrome plated



Anodized aluminium



Plastic Handles

Wide range of styles, materials and sizes available

### Rubber Feet: 26-1421 Series

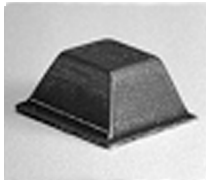

Square Taper



Square



Flat Round

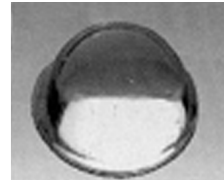

Hemisphere



Round

Refer also to the wide range of Hi-Q plastic and rubber feet.

### Tilt Stands

Three sizes with mounting centers

26-1427D5 139.7mm

26-1427D7 177.8mm

26-1427D10 254.0mm

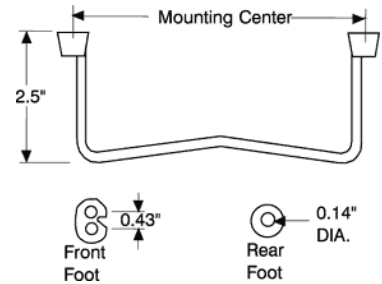

### Plastic Feet



Black polyamide spring  
locked folding legs  
26-M3784-7001

White ABS folding legs  
26-1427X

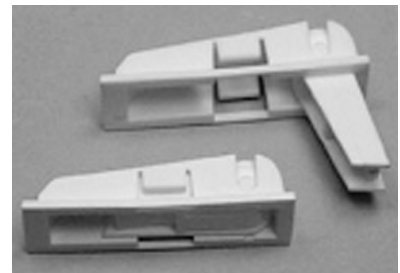

### Cable Wrap



Grey plastic cord wrap  
Sold in pairs. Secured by two clips  
each (included) 26-M765

## Hammond Accessories

A wide range of accessories are available for Hammond enclosures.

Refer [www.hammondmfg.com](http://www.hammondmfg.com) for the full range, part numbers and dimensions.

### DIN Clip

For Series 1427

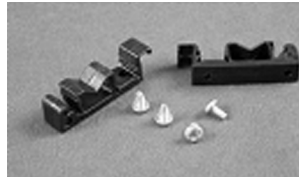

### Battery Dividers

For Series 1599

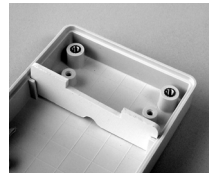
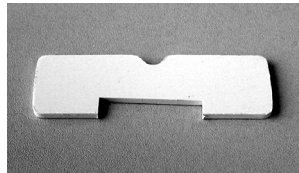

### Belt or Pocket Clips

Black 26-1599CLIP  
Grey 26-1599CLIPGY

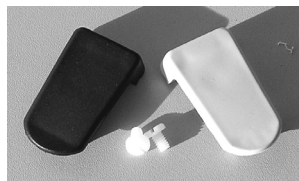

### Battery Holders

1 or 2 AA, 1,2,3 or 4 AAA

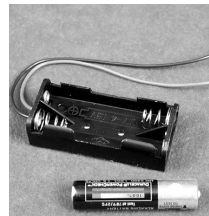
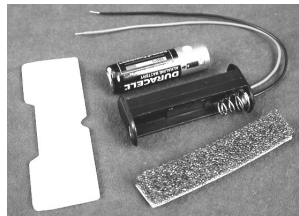

### Infrared Panel

For Series 1593

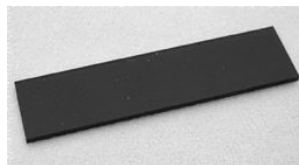

### Clear Plastic Lids

For Series 1591



### PCB Adaptors

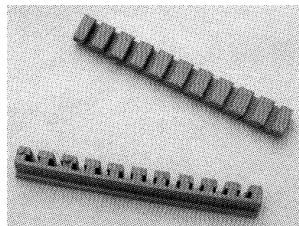

For Series 1591 and  
ribbed 1590 only.

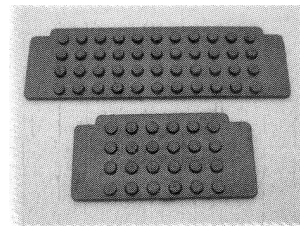

For Series 1594

### Screws

Self Tappers #2 x 4.8,  
#4 x 6.4, x12.7, x15.9, x19.2, x25.4, x33.3mm,  
#6 x 6.4.

Machine Screws 6-32 x 12.7mm,  
M3 x 10, x18, x25, x28mm

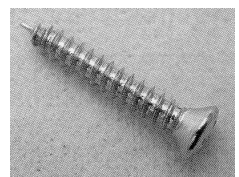
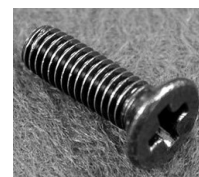

## Mechanical, Thermal & Electrical Properties of Plastic Materials

Property	Units	Test Method	ABS	ABS FR	Polystyrene	Polycarbonate	GRP
Tensile Strength@ Yield	PSI	ASTMD638	5,890	5,250	3,200	10,000	6,000
Tensile Elongation@ Break	%	ASTMD638	22	15	50	100	0.5
Tensile Modulus	PSI	ASTMD638	290,000	260,000	285,000	810,000	1,600,000
Flexural Modulus	PSI	ASTMD790	290,000	260,000	285,000	810,000	1,600,000
Flexural Strength	PSI	ASTMD790	8200	6800	18,100	17,000	15,000
Izon Impact (1/8") - notched	Ft Lb/ Inch	ASTMD256	4.5	3.9	2.1	16	4.5
Specific Gravity - Solid	-	ASTMD792	1.04	1.22	1.17	1.2	1.95
Hardness, Rockwell R	R	ASTMD785	100	100	40	118	40
Melt Index	GM/10Min	ASTMD1288	3	4	3	7	-
Heat Deflection@ 455 KPA	° C	ASTMD648	96	85	87	140	200
Temperature @ 1820 KPA	° C	ASTMD648	83	74	-	131	-
Vican Softening Temp.	° C	ASTMD1525	103	88	95	154	-
Flame Characteristics	-	UL94	HB	VO	HB	HB	VO
Thermal Conductivity	W/M.C	ASTMC177	0.19	-	0.16	0.19	0.001
Specific Volume Resistance	Ω/cm	ASTMD257	10 E 15	10 E 13	10 E 16	10 E 16	10 E 15
Dielectric Strength	V/Mil	ASTMD149	140	400	215	160	400
Water Absorbtion	%	ASTMD570	0.3	-	0.1	0.15	0.16

Values may vary between material manufacturers and within normal manufacturing tolerances.

### Resistance of material at room temperature to different media.

Simultaneous exposure to different media may alter the resistive properties of a material.

To be safe, it is advisable to trial test the boxes for sufficient resistance to the media.

Material	Polystyrene	AB	FR ABS	Polycarbonate
Gasoline	Unstable	Relatively Stable	Relatively Stable	Unstable
Diesel Oil	Unstable	Stable	Stable	Relatively Stable
Sea Water	Stable	Stable	Stable	Unstable
Hydrochloric Acid 10%	Stable	Stable	Relatively Stable	Stable
Weak Alkaline	Stable	Stable	Stable	Unstable
Strong Alkaline Solution	Stable	Stable	Stable	Unstable
Atmospheric Influences	Relatively Stable	Relatively Stable	Relatively Stable	Stable
Lactic Acid	Stable	Stable	Stable	Stable
Acetone	Unstable	Unstable	Unstable	Unstable

### I.P. Protection Classification

Degrees of water protection

1st Digit	Protection	Brief Explanation	2nd Digit	Protection	Brief Explanation
3	Small foreign bodies	Protection of personnel from accidental touching active parts with objects larger than 2,5mm in dia.	3	Spray Water	Water drops falling at any angle up to 15° from the vertical not to have any harmful effect.
4	Granular foreign bodies	Protection of personnel from touching internal parts with tools or objects thicker than 1mm.	4	Splash Water	Water splashing on the object from all directions not to have harmful effect.
5	Deposits of dust	Total protection from touching voltage or internal moving parts. Protection from harmful deposit of dust. Access of dust is not completely prevented. Access of dust is not completely prevented.	5	Jet Water	A jet of water nozzled from all directions must not have any harmful effect.
6	Access of dust	Total protection from touching voltage or internal moving parts. Protection from access of dust.	6	Flooding	Water from temporary flooding, such as heavy seas, must not enter in harmful quantity.
			7	Dipped state	If the object is dipped into water, water must not enter in harmful qty.
			8	Submerged state	If the object is submerged in water, water must not enter in harmful qty.



## Electronic Components

For the electronics, electrical and general manufacturing industries

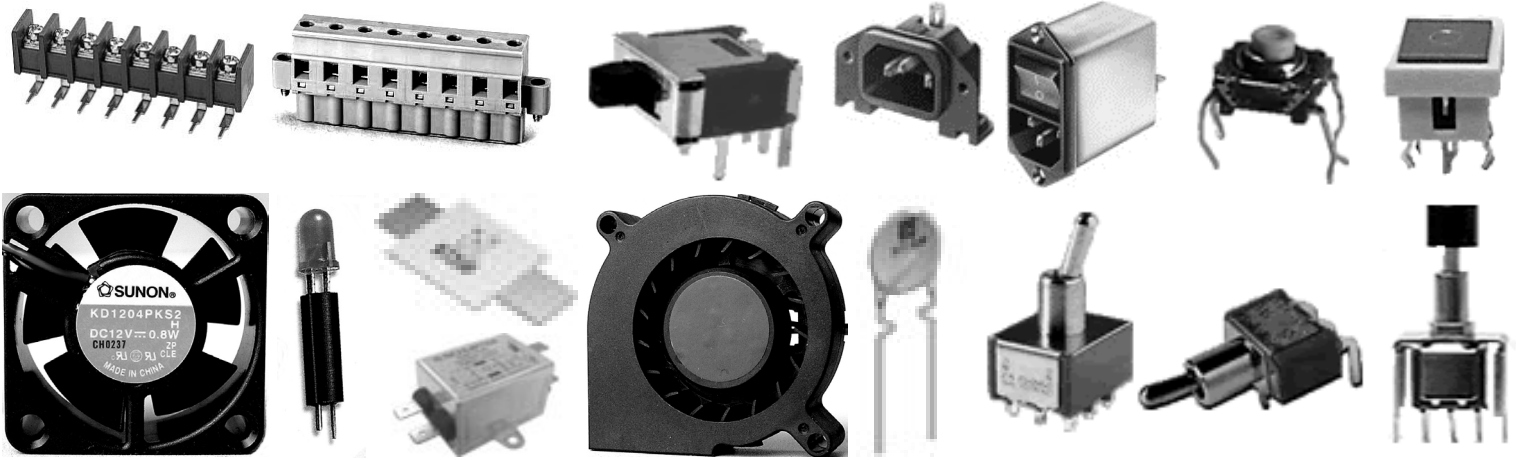

## Hi-Q Plastic Components

For the electronics, electrical and general manufacturing industries

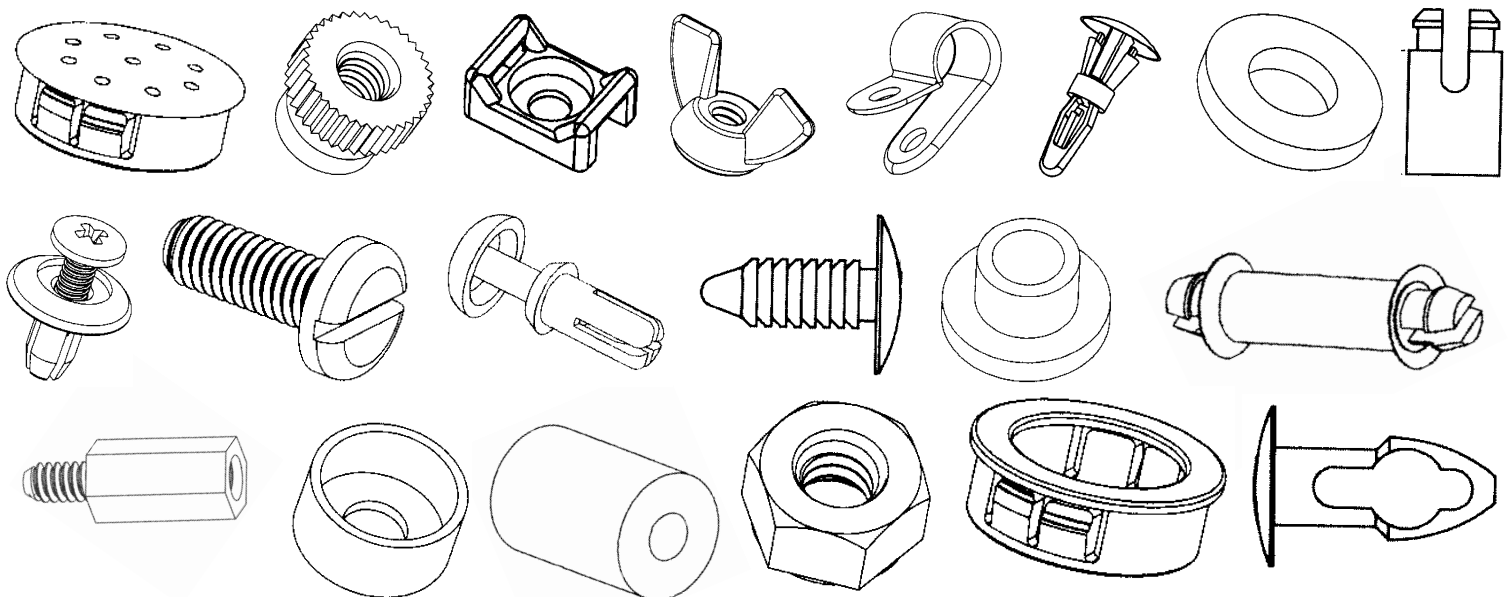

## StockCap Protective Caps and Plugs

For Powder Coating, Electroplating, Refrigeration, Hydraulic and General Industry



Wide range of stock available

Notes:

Notes: